

Product Catalogue

Cascando



Energising  
Spaces

**Cascando**

PRODUCT CATALOGUE

Charming people's workplace  
with a touch of joy.

# Colours



**Light blue**  
NCS S 2040-B20G



**Orange red**  
NCS S 1080-Y70R



**Traffic black**  
RAL 9017



**Dark green**  
NCS S 5540-G50Y



**Orange**  
RAL 2008



**Basalt black**  
NCS S 8000-N



**Olive green**  
NCS S 2060-G80Y



**Warm grey**  
NCS S5010-Y10R



**Basalt grey**  
RAL 7012



**Lime green**  
Sikkens G4.60.70



**Yellow grey**  
RAL 7034



**Anthracite grey**  
RAL 7016



**Citron yellow**  
RAL 1012



**Quartz grey**  
RAL 7039



**Grey white**  
RAL 9002



**Signal yellow**  
RAL 1003



**Light grey**  
NCS S 4000-N



**Traffic white**  
RAL 9016



**Yellow**  
NCS S 0560-Y



**Aluminium**  
RAL 9006

# Wood colours

Colours and materials can differ from image, for a true colour perspective, please use a RAL or NSC colour card



**Natural**  
Oak



**Red**  
NCS 1080-Y80R



**Black**



**Natural**  
Pressed bamboo



**Yellow**  
NCS S 2040-B20G



**Dark grey**  
NCS 9000-N



**Natural**  
Ash



**Blue**  
NCS S 2040-B20G



**Mid grey**  
NCS 6005-R80B



**White**



**Dark green**  
NCS S 2040-B20G



**White grey**  
NCS 0300-N

# Laminates



**Anthracite**  
Pfleiderer  
U12290 VV



**Oak**  
Pfleiderer  
R20010 NW



**Grey white**  
Pfleiderer

---



**Opal white**  
Pfleiderer  
W1003 VV



**Ash**  
Pfleiderer  
R20010 NW

---

# Metal finishes



**Anodized aluminium**



**Chrome**



**Polished aluminium**

---



**Stainless steel**

---

## Visit our website for:

- 3D CAD data
- OFML data
- pCon Planner DWG files
- High Resolution images
- Product sheets
- Assembly instructions
- Maintenance instructions

## Contact our sales department for:

- Project samples
- Material samples
- Fabric sheets
- Own fabrics
- Special colours, special dimensions
- Price list
- Product catalogue
- Request for quotation
- Express delivery
- Conditions of sale and delivery

**Cascando Products b.v.** T +31(0)26 35 19 603  
Impact 2 F +31(0)26 35 19 808  
NL-6921 RZ Duiven E design@cascando.nl  
The Netherlands I www.cascando.nl

## STAY CONNECTED:





## 16 We connect

Collaboration is the key to progress.



## 10 We manufacture

Every team member has a part in certifying product excellence.



|                              |     |
|------------------------------|-----|
| Energising spaces            | 4   |
| Catching the spirit of times | 6   |
| Excelling in every step      | 10  |
| Welcoming office spaces      | 16  |
| Designers                    | 18  |
| Sound absorption             | 48  |
| Fabrics                      | 268 |
| Projects                     | 298 |
| 3D and OFML data             | 308 |
| Product index                | 310 |

# Contents

|   |     |
|---|-----|
| <b>Seating</b>                          | 22  |
| <b>Privacy &amp; acoustic furniture</b> | 46  |
| <b>Coat stands</b>                      | 98  |
| <b>Coat racks</b>                       | 134 |
| <b>Coat hooks</b>                       | 156 |
| <b>Coat hangers</b>                     | 178 |
| <b>Tables</b>                           | 184 |
| <b>Display and storage</b>              | 210 |
| <b>Whiteboards</b>                      | 234 |
| <b>Planters</b>                         | 248 |
| <b>Umbrella stands</b>                  | 252 |
| <b>Paper bins</b>                       | 262 |



## Cascando. Energising spaces.

Cascando designs and manufactures contemporary furniture, accessories and acoustic solutions. With these interior products, we encourage people to have fun at work and at the same time add functional value to a brand's identity and output. Leon Waltmans: 'It is our mission to develop well-designed, functional products that touch up the workspace with a certain flair. We simply believe an enjoyable space is built from inspirational elements that together energise a positive state of mind. From this basic idea, we address the challenges in the office habitat today: empowering individuals, stimulating interaction and vitalising productivity.'

Cascando entwirft und fertigt moderne Möbel, Accessoires und Akustiklösungen. Mit unseren Entwürfen wollen wir erreichen, dass Menschen Spaß an der Arbeit haben, die Markenidentität des Unternehmens verstärkt wird und die Produktivität zunimmt. Leon Waltmans: „Wir haben uns zum Ziel gesetzt, gut entworfene, funktionelle Produkte zu entwickeln, die jedem Arbeitsumfeld ein gewisses Flair verleihen. Wir sind einfach davon überzeugt, dass eine angenehme Umgebung sich aus inspirierenden Elementen aufbaut, die gemeinsam für einen positiven Gemütszustand sorgen. Von diesem Grundgedanken ausgehend gehen wir die Herausforderungen einer modernen Büroumgebung an – Stärkung der individuellen Fähigkeiten, Förderung des Miteinanders und Ankurbeln der Produktivität.“

**'An enjoyable space is built from inspirational elements that together energise a positive state of mind'**

**LEON WALTMANS**  
Managing Director







## Catching the spirit of times. We design.

**Cascando designs are a result of a constant dialogue with designers and architects. They challenge us, we challenge them. Together we develop original products that not only add functionalities to people's workspaces but will also boost their engagement, wellbeing and energy. Laura de Lossantos Parola: 'How do you design a lively atmosphere in an open workspace where people can switch from 'formal to informal' and from 'private to communal' in minutes? The power of a space is made from the sum of its parts. Shape, style, material, colour palette, all these elements feed on our sensibility to catch the spirit of times. We fuse these essentials into practical products that put a little smile on people's faces.'**

Die Cascando-Entwürfe entstehen aus einem konstanten Dialog mit Designern und Architekten. Gegenseitig fordern wir uns heraus. In Zusammenarbeit entwickeln wir originelle Produkte, die dem Arbeitsumfeld zusätzliche Funktionen verleihen und zugleich den Einsatz, das Wohlbefinden und das Energieniveau der Mitarbeiter steigern. Laura de Lossantos Parola: „Wie schafft man eine lebendige Atmosphäre in einer offenen Bürolandschaft, wo man innerhalb von Minuten von formell auf informell, von privat auf gemeinschaftlich umschalten kann? Die Energie eines Raums ergibt sich aus der Summe seiner Teile. Form, Stil, Material, Farbspektrum – all diese Elemente werden durch unser Gefühl für den Zeitgeist bestimmt. Wir verschmelzen diese Kernelemente zu praktischen Produkten, die einfach fröhlich machen.“



**'The power of a space  
is made from the sum  
of its parts'**

**LAURA DE LOSSANTOS PAROLA**  
Product Designer



Building a perfect product  
starts with the will to  
exceed expectations.





**'Every team member  
has a part in certifying  
product excellence'**

**BART VAN DER HORST**  
Manufacturing & Logistics Coordinator





## Excelling in every step. We manufacture.

**At Cascando's production facilities in Duiven (the Netherlands) everything is centered around creating customer value. Our team is driven to excel in every step of the process. Smart logistics allow us to efficiently manufacture products and guarantee quick global delivery.**

**Bart van der Horst: 'In our production plant and warehouse we handle more than one million parts per year. Every team member feels obliged to exceed customer expectations and has a part in certifying product excellence. Together we make sure we deliver. Every day!'**

In Cascandos Produktionsstätte in Duiven (Niederlande) dreht sich alles um das Schaffen von Werten für die Kunden. Unser engagiertes Team gibt in jeder Prozessphase immer sein Bestes. Dank einer ausgeklügelten Logistik können wir unsere Produkte effizient herstellen und kurze internationale Lieferfristen garantieren. Bart van der Horst: „In unserer Produktions- und Lagerstätte werden jährlich über eine Million Teile verarbeitet. Jedes einzelne Mitglied unseres Teams strebt danach, die Kundenerwartungen zu übertreffen, und trägt zur herausragenden Qualität unserer Produkte bei. Gemeinsam stellen wir sicher, dass Sie das Gewünschte bekommen. Jeden Tag aufs Neue.“





VOETPLAAT 5,8K  
EUREGIO 01 0000  
1 810000

010  
10332 - C4007 PRA  
130446 - 1  
100x







CE wolcraft® GmbH  
D-56746 Kempenich  
Germany



## Welcoming office spaces. We connect.

Cascando gladly takes up the challenge to acclimatise office spaces to the new working ethos of the 21st century, together with interior designers and architects. We are engaged to deliver a complete range of interior accessories, seating elements and acoustic furniture. Welcoming products that signal the essence of a company's identity - its 'yellow brick road'. Showing vitality, creativity and pleasure. Matthijs ten Kleij: 'Understanding the operational needs and culture of clients comes natural to us. Collaboration is the key to real progress. Together with our international network of agents, dealers and architects we help to create smart, sustainable and beautiful workplaces. Commitment with the aim to create 'return on attention' - profitable for everyone involved.'

Büroräume an das neue Arbeiten des 21. Jahrhunderts anzupassen, ist eine Herausforderung, die Cascando in Zusammenarbeit mit Inneneinrichtern und Architekten gerne annimmt. Wir bieten ein komplettes Sortiment an Sitzelementen, akustischen Möbeln und Accessoires. Einladende Produkte, die Vitalität, Kreativität und Spaß vermitteln und so die Essenz der Unternehmensidentität zum Ausdruck bringen. Matthijs ten Kleij: „Wir haben ein natürliches Verständnis der betrieblichen Bedürfnisse und Unternehmenskultur unserer Kunden. Zusammenarbeit ist der Schlüssel zum Fortschritt. Zusammen mit unserem internationalen Netzwerk von Vertretern, Händlern und Architekten schaffen wir Arbeitsumgebungen, die intelligent eingerichtet, nachhaltig und schön sind. Unser Engagement richtet sich auf einen hohen Return on Attention, sodass alle Beteiligten profitieren.“



**'Collaboration is the key  
to real progress'**

**MATTHIJS TEN KLEIJ**  
Operational Manager



Designers



---

## ROBERT BRONWASSER

Designer & art director

**Graduated with distinction as an Industrial Designer from Delft University in 1992. He passionately merges creative skills, commonsense and 25 years' experience into useful designs with a one-off look - to put a daily smile on your face.** Bronwasser hat sein Studium an der Technischen Universität Delft 1992 „cum laude“ abgeschlossen. Heute ist er ein Industriedesigner, der mit Leidenschaft kreative Fertigkeiten, gesunden Menschenverstand und 25 Jahre Erfahrung miteinander verbindet, um einen einmaligen Look zu schaffen, der dem Betrachter jedes Mal aufs Neue ein Lächeln entlockt.

---



---

## PETER VAN DE WATER

Furniture & interior designer

**Graduated from the Artschool St. Joost in Architecture & Spatial design. 'Intelligent simplicity' is typical for his furniture designs. His development is shown in his designs for Cascando: from minimalist (like the U2 tables) to more playful, but always looking for that one perfect durable solution to combine aesthetics, function and construction.** Graduierte von der Artschool St. Joost in Architektur und Raumgestaltung. Typisch für sein Design ist die intelligente Einfachheit. Seine Entwicklung wird in seinen Entwürfen für Cascando gezeigt: Von minimalistisch (wie die U2-Tischen) zu mehr spielerisch, aber immer auf der Suche nach der perfekten dauerhaften Lösung wo Ästhetik, Funktion und Konstruktion zusammenkommen.

---



---

## MINKE VAN VOORTHUIZEN

Product designer

**Graduated as Product Designer at the ArtEZ (School of Arts) in Arnhem. Her organic style is characterised by the combination of construction and mold. The Tango coat stands are a signature of this vision.** Graduierte Produkt Designer an der ArtEZ (Hochschule für Künste) in Arnhem. Ihr Stil wird gekennzeichnet durch die Kombination von Konstruktion und Matrize. Die Tango Garderobenständer sind eine Signatur dieser Vision.

---



---

## EMILIANA ANA MIR & EMILI PADRÓS

Designers

**They met during their MA in Industrial Design at the Central Saint Martins School in London. Their vision of design comes from experimentation and the prospect of new scenarios, where they pursue relations between objects and spaces. Spaces in which the user should be as participatory, moved and creative as possible.**

Sie trafen sich während ihrer MA in Industrial Design an der Central Saint Martins School in London. Ihre Vision von Design stammt aus Experiment und der Aussicht auf neue Szenarien, in denen sie Beziehungen zwischen Objekten und Räumen suchen. Umgebungen in denen der Benutzer so teilnehmend, bewegt und kreativ wie möglich ist.

---

---

## SILVIO ROHRMOSER

Furniture designer

**South-German furniture designer with a characteristic, minimalist design approach. "My products, like the Box01 storage system, are used in various different ways and are tailored to the requirements of the individual user."**

Süddeutscher Möbeldesigner, der durch seine minimalistische Annäherung an das Design hohen Wiedererkennungswert hat. „Meine Produkte, wie das Aufbewahrungssystem Box01, werden auf die unterschiedlichsten Arten verwendet und sind auf die Bedürfnisse der individuellen Verbraucher abgestimmt.“

---



---

## MARLEEN VALSTAR

Designer & interior architect

**Studied furniture design and architectural design at the Academy of Visual Arts in Maastricht. Since 1998, she has been working as a product designer and interior architect. "A product has to work, both in terms of design and function. Neither aspect is less important than the other".** Studierte Möbeldesign und Architektonische Gestaltung an der Akademie der Bildenden Künste in Maastricht. Arbeitet seit 1998 als Produktdesigner und Innenarchitekt. "Ein Entwurf muss stimmen, sowohl in der Gestaltung als auch in der Funktion. Keine von beiden spielt dabei eine untergeordnete Rolle."

---



---

## ONNO DE KNEGT

Designer & interior architect

**Active since 1986 as an interior architect and project designer. His designs are characterised by peace and neutrality, both in material and color use. "I am a supporter of fair, tight and timeless designs that are broadly and sustainable usable for the user."** Seit 1986 tätig als Architekt und Designer. Seine Entwürfe sind durch Frieden und Neutralität geprägt, sowohl in Material und Farbe. "Ich bin ein Anhänger von fairen, straffen und zeitlosen Designs, welche breit und nachhaltig nutzbar sind für den Benutzer."

---

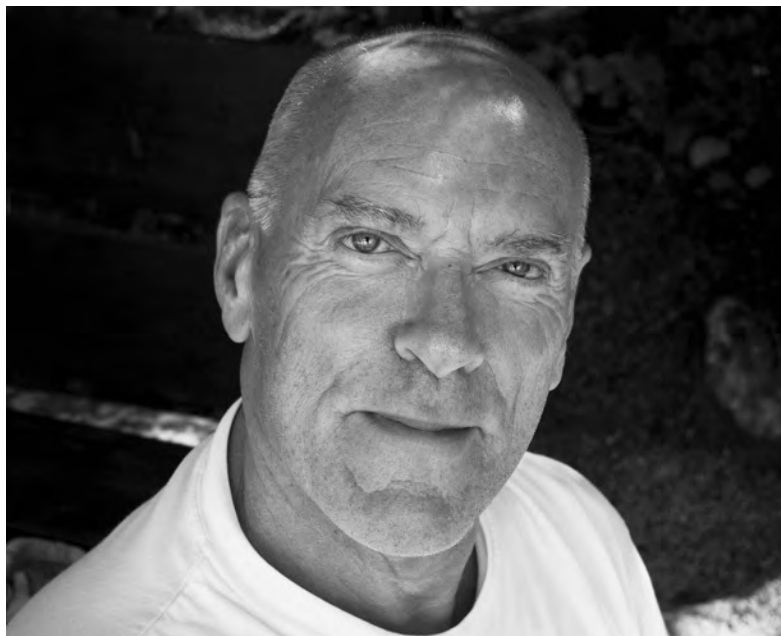

20 / 21

---

## GERALD BRANDSTÄTTER

Interior architect & designer

**Studied at the art school in Zurich and at the Art Center College of Design in Pasadena, U.S.A. In 1994, he established his design studio CONCEPT-B, where German rationalism and Italian elegance merge with Swiss precision. His designs for Cascando are „good designs geared towards people and their many different needs.“** Studierte an der Kunstschule in Zürich und am Art Center College von Design in Pasadena, USA. Im Jahr 1994 gründete er sein Designstudio KONZEPT-B, in dem der deutsche Rationalismus und die italienische Eleganz mit Schweizer Präzision verschmelzen. Seine Entwürfe für Cascando sind "gute Designs gegenüber den Menschen und ihren vielfältigen Bedürfnissen."

---



---

## PHIL PROCTER

Product designer

**Following his graduation from Buckinghamshire University Phil established his design studio in 2011. Based on considered observations and simple formal gestures, he designs everyday objects that seek to bring us joy in both their utility and appearance.** Nach Abschluss seines Studiums an der Buckinghamshire University gründete er 2011 sein eigenes Designstudio. Basierend auf Beobachtungen und einfachen formalen Gesten entwirft er Alltagsgegenstände, die sowohl schön als auch praktisch sind und dadurch den Benutzer Freude bringen.

---



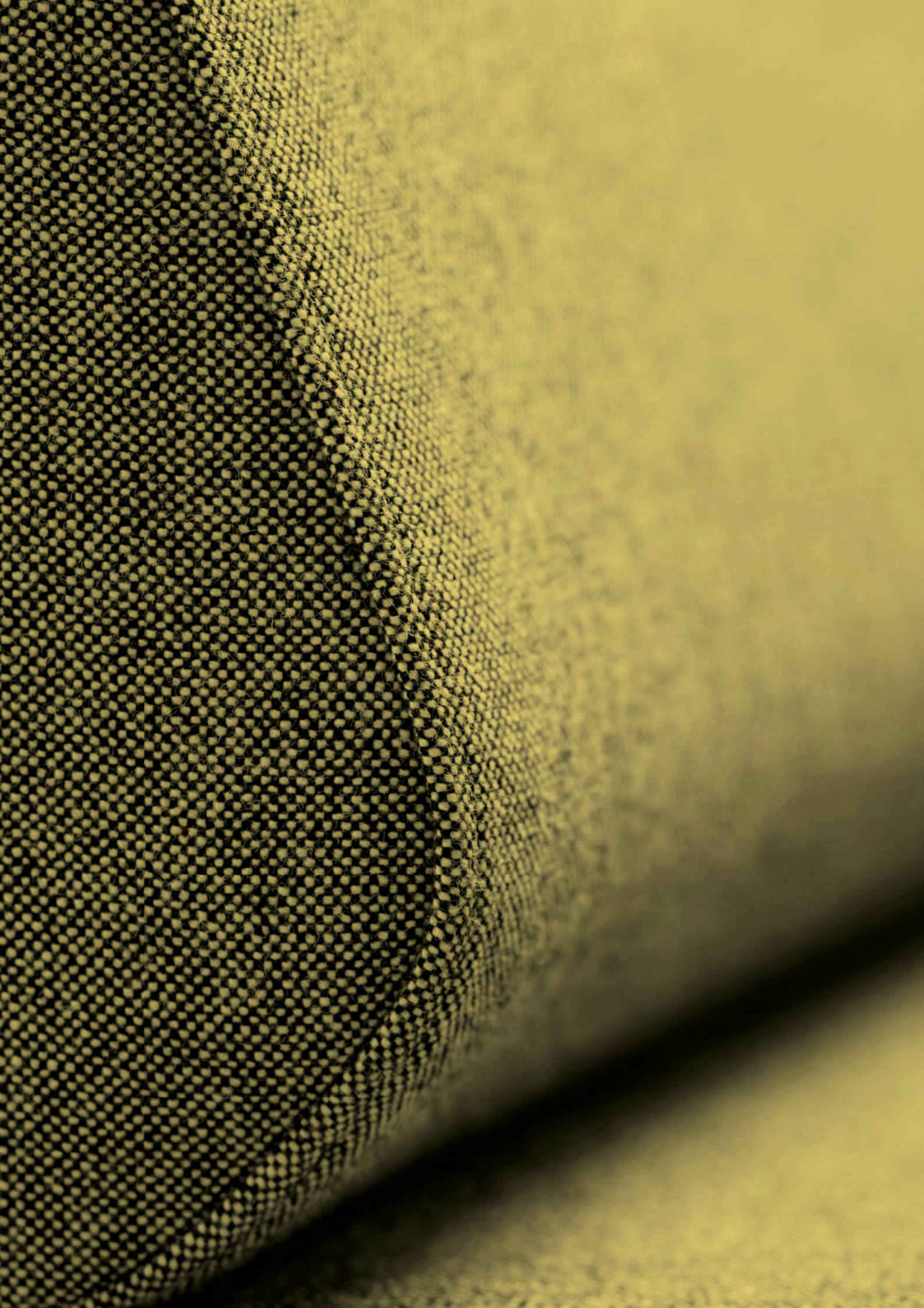

# Seating

# Team

DESIGN PETER VAN DE WATER







# Team LSM

DESIGN PETER VAN DE WATER

Waiting, a quick meeting, informing a peer, working and socializing. Team is a very stylish modular seating concept creating original and flexible designs for an entrance, lounge or open office. It's a box of blocks that stimulates the imagination into maximizing any space. Team is available in two versions; Basic Seating Module (BSM) and Light Seating Module (LSM). Team LSM is characterized by its airy steel frame with soft rounded corners, Team BSM is equipped with stable feet or a solid plinth.

Warten, kurze Besprechungen führen, Kollegen informieren, arbeiten und begegnen. Team ist ein modulares Sitzsystem mit Stil, mit dem originelle und flexible Konstellationen für Eingangsbereiche, Begegnungsbereiche oder Großraumbüros geschaffen werden können. Ein Baukasten, der die Fantasie stimuliert, um das Potenzial eines Raums optimal auszuschöpfen. Team ist in zwei Versionen erhältlich: Basic Seating Module (BSM) und Light Seating Module (LSM). Team LSM kennzeichnet sich durch luftige Stahlrahmen mit abgerundeten Ecken, Team BSM steht auf stabilen Füßen oder Sockeln.



# Team

DESIGN PETER VAN DE WATER









# Team BSM

DESIGN PETER VAN DE WATER

Team Basic Seating Module (BSM) offers an appealing and representative design for any entrance or informal meeting zone. The active seating comfort is very pleasant. The Team BSM version is equipped with wooden feet or plinths and comes in various sizes. The integration of power and data connections is also possible.

Team Basic Seating Module (BSM) bietet ein ansprechendes und repräsentatives Design für jeden Eingangs- oder Begegnungsbereich. Es lädt zum aktiven Sitzen ein und ist dabei angenehm bequem. Diese Team-Version hat Holzfüße oder -sockel und ist in verschiedenen Größen erhältlich. Bei Bedarf können auch Strom- und Datenanschlüsse integriert werden.





# Team

DESIGN PETER VAN DE WATER

Team Basic Seating Modules (BSM) are equipped with feet in ash wood, with natural, white or black finish. A black plinth is available as option. Team Light Seating Modules (LSM) have a powder coated steel frame in RAL9002 white grey. Glides for use on hard floors are included. Both series are couplable (option). Team Seating Modules can be extended with privacy and acoustic panels (see chapter "Privacy & acoustic furniture").

Die Team Basis Sitzelemente (BSM) werden regulär mit Füßen aus Eschenholz in den Farben Natur, Weiss oder Schwarz geliefert. Die Ausstattung mit einer schwarzen Blende wird als Option angeboten. Die Team Light Sitzelemente (LSM) werden mit einem pulverbeschichtetem Untergestell in der Farbe RAL9002, Grauweiss, geliefert. Kunststoff Gleiter zum Schutz von harten Böden sind einbegriffen. Alle Sitzelmente innerhalb der Team Basis als auch der Team Light Serie können miteinander verbunden werden. Team Sitz Elemente können mit Paneelen für Sichtschutz und Akustik ausgestattet werden (siehe Kapitel "Privacy & acoustic furniture").

## MATERIAL AND FINISH

Wooden frame with upholstered foam  
 Team BSM: feet in ash wood  
 Team LSM: powder coated steel frame

## COLOUR FRAME LSM



GREY WHITE

## COLOURS FEET BSM



ASHWOOD

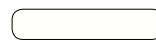

WHITE



BLACK

## FABRICS

Choose from a wide range of fabrics shown in chapter Fabrics

## TEAM LSM DIMENSIONS (CM)

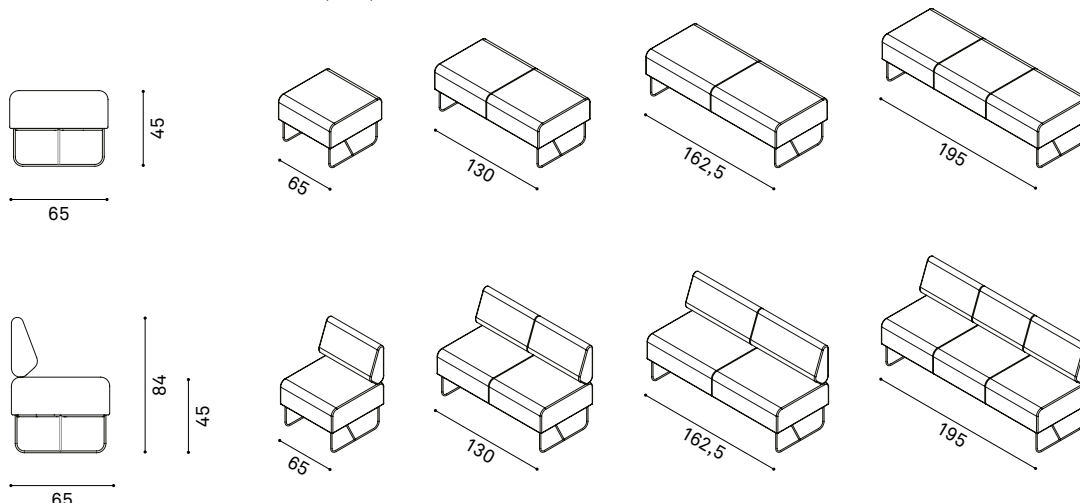

## TEAM BSM DIMENSIONS (CM)

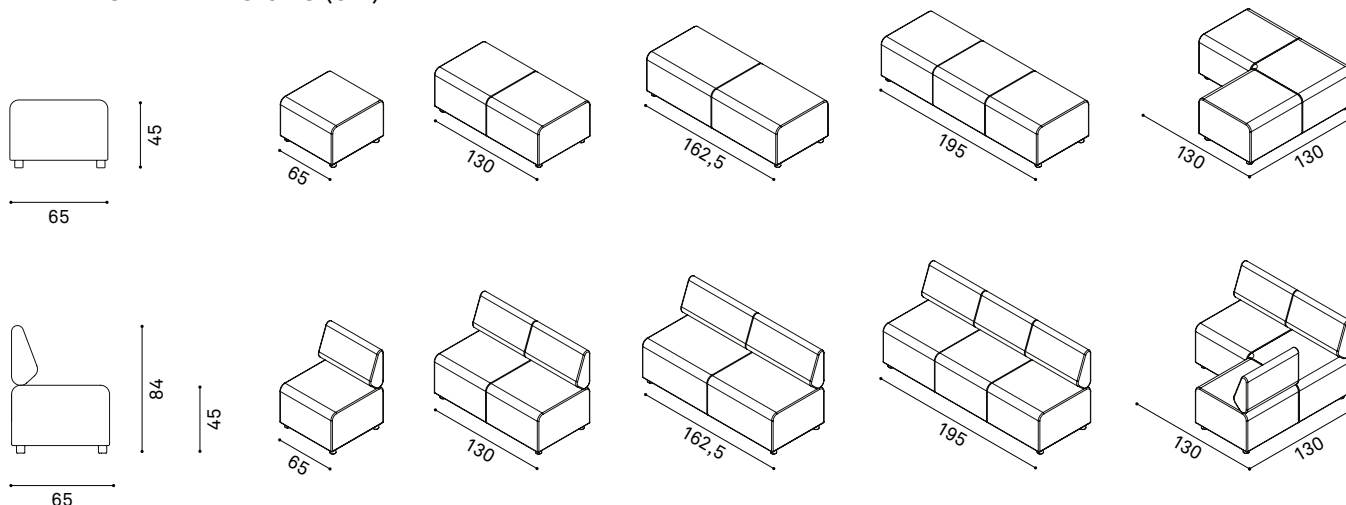

# Team

DESIGN PETER VAN DE WATER





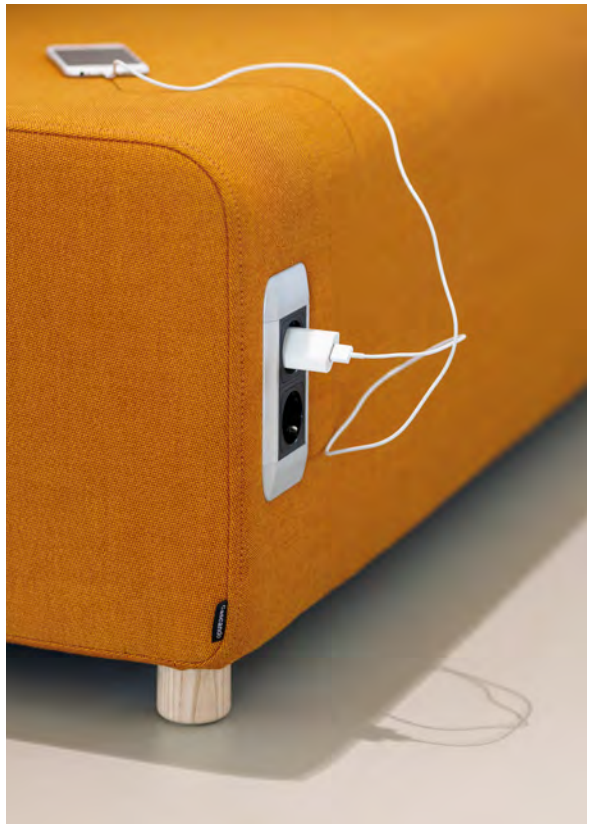

# Team SPS

DESIGN PETER VAN DE WATER

Team Solid Panel System (SPS) is a stylish 360° concept, integrating every single function a waiting room or meeting lounge needs. The panels offer comfort and privacy to visitors and co-workers. They are available in various heights and widths; enabling tailor-made space configurations. The series includes matching accessories such as tables, magazine holders and plant holders. They can easily be integrated by placing them on the panel. Power/data integration is also available.

Team Solid Panel System (SPS) ist ein elegantes 360°-Konzept, das alle Funktionen, die man sich in einem Warte- oder Begegnungsbereich wünscht, in sich vereint. Die Paneele bieten Besuchern und Mitarbeitern nicht nur Komfort, sondern auch Privatsphäre. Sie sind in verschiedenen Höhen und Breiten erhältlich, sodass bedarfsgerechte Raumkonfigurationen geschaffen werden können. Die Serie umfasst auch passendes Zubehör, z. B. Tische, Zeitschriftenhalter und Pflanzgefäße, die einfach an den Paneelen angebracht werden können. Auch Strom- und Datenanschlüsse können integriert werden.







# Team SPS

DESIGN PETER VAN DE WATER

Panels are available in different heights. Heights 140/160/190 cm see chapter "Privacy & acoustic furniture".  
Seating elements with or without backrest can be applied.

Die Paneele sind in verschiedenen Höhen lieferbar. Für Höhen von 140/160/190cm siehe Kapitel "Privacy & acoustic furniture". Sowohl Sitzelemente mit als auch ohne Rückenlehne können für dieses System verwendet werden.

## MATERIAL

Light weight wooden panel

## COLOURS PANELS



OPAL WHITE

GREY WHITE

ANTHRACITE



OAK

## COLOUR ACCESSORIES



TRAFFIC WHITE

## DIMENSIONS (CM) (HEIGHT INCLUDES FEET)

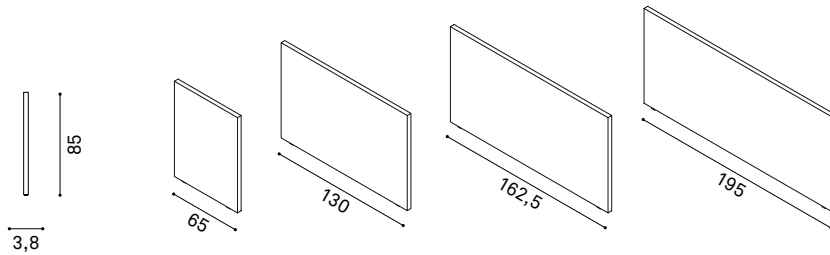

## CONFIGURATION EXAMPLES

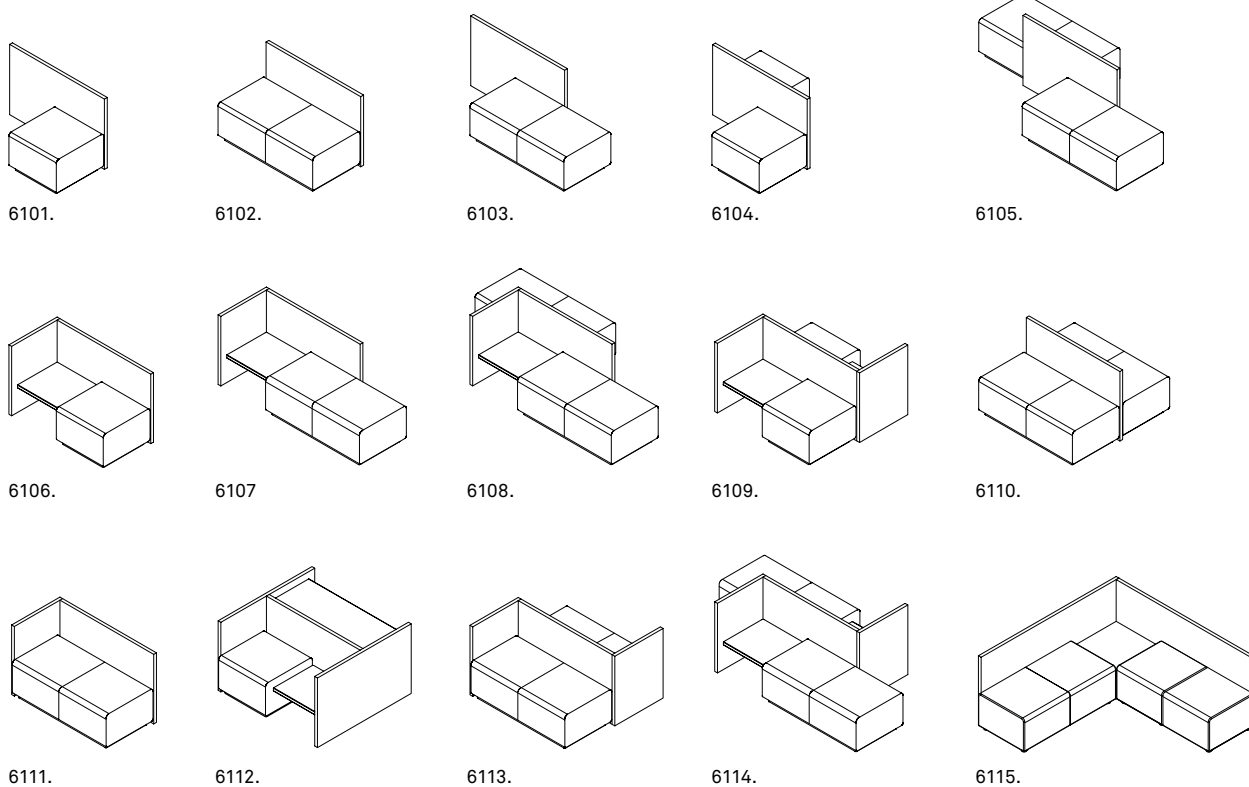

## ACCESSORIES

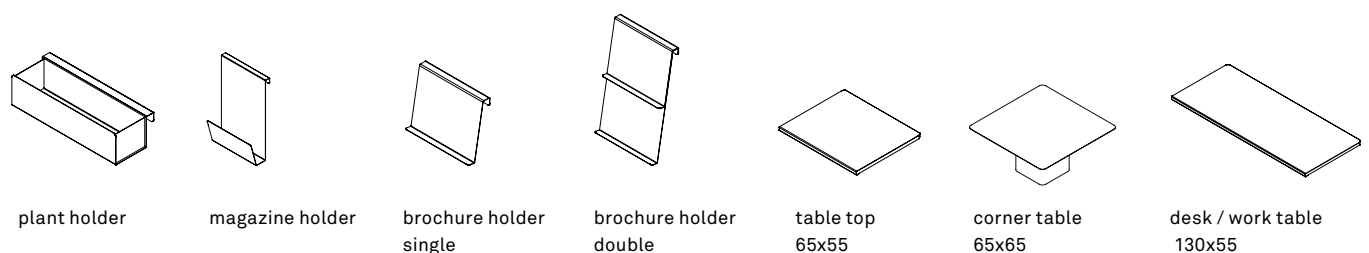

plant holder

magazine holder

brochure holder  
single

brochure holder  
double

table top  
65x55

corner table  
65x65

desk / work table  
130x55



# Pully

DESIGN ROBERT BRONWASSER

Pully is a pouf with a different kind of shape that defies convention. The leather handle makes it easy to carry Pully around, offering comfort and flexibility in the workplace.

Pully ist der unkonventionelle Hocker mit der etwas anderen Form. An seinem Ledergriff lässt er sich mühelos herum tragen, sodass man seinen flexiblen Komfort überall am Arbeitsplatz genießen kann.

## MATERIAL AND FINISH

Upholstered foam  
Leather tag

## FABRICS

Choose from a wide range of fabrics shown in chapter Fabrics

## DIMENSIONS (CM)

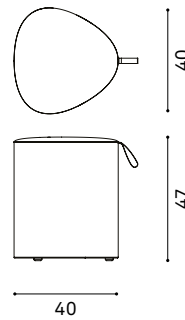



# Paddy

DESIGN PETER VAN DE WATER

The round shape of Paddy suggests that using the stool will stimulate a friendship. While the comfortable upper is made of fabric, the chassis is fashioned from threaded steel.

Mit seinen runden Formen ist Paddy ein Hocker, auf dem Freundschaften gedeihen können. Der bequeme Sitz ist mit Stoff bezogen und ruht auf einem Gestell aus Stahldraht.

## MATERIAL AND FINISH

Upholstered foam  
Steel powder coated frame

## COLOUR FRAME

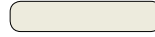

GREY WHITE

## FABRICS

Choose from a wide range of fabrics shown in chapter Fabrics

## DIMENSIONS (CM)

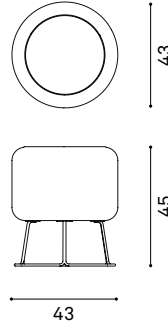



# Team Pouf

DESIGN PETER VAN DE WATER

The pouf version of the Team seating elements.  
The simple yet elegant pouf can be easily combined with any of the Team elements.

Der Hocker unter den Team-Sitzelementen.  
Dieser einfache, aber elegante Hocker lässt sich gut mit allen anderen Team-Modulen kombinieren.

## MATERIAL AND FINISH

Upholstered foam

## FABRICS

Choose from a wide range of fabrics shown in chapter Fabrics

## DIMENSIONS (CM)

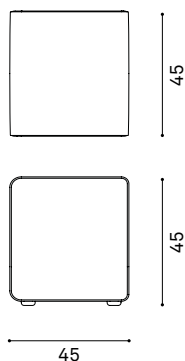





# Privacy & acoustic furniture



## Why sound absorption is a major challenge in spatial design.

In every spatial design, it is a challenge to arrange a balance between collaborative spaces and concentration zones. While openness may add to the success of collaboration and group productivity, excessive sound disruption may influence the output and wellbeing of individual workers. What approach will enable you to deliver the right amount of privacy?

Using smart acoustic furniture is an effective way to optimize acoustic properties in a space. Cascando's privacy & acoustic furniture will allow you to fuse great design to the functionality of first-rate sound control. We offer innovative sound absorbing space dividers and a broad selection of acoustic wall panels, desk and ceiling panels. Sustainable solutions that will surely upgrade the working atmosphere of a workspace.

**Our acoustic solutions are available with standard or premium absorbing properties. Standard acoustic properties are equal to Acoustic Class C (DIN-ISO 354:2003). Premium acoustic properties are equal to Acoustic Class A (DIN-ISO 354:2003). Detailed information can be found on our website: [www.cascando.nl](http://www.cascando.nl)**

Unsere Akustiklösungen sind in Standard- oder Premium-Absorberqualität erhältlich. Die Standard-Absorberqualität entspricht Absorberklasse C (DIN-ISO 354:2003). Die Premium-Absorberqualität entspricht Absorberklasse A (DIN-ISO 354:2003). Ausführliche Informationen dazu finden Sie auf unserer Website: [www.cascando.nl](http://www.cascando.nl).

In jeder offenen Raumstruktur ist es eine Herausforderung, ein Gleichgewicht zwischen gemeinschaftlichen Bereichen und Privatsphäre zu schaffen. Während die offene Struktur sich positiv auf die Zusammenarbeit und Gruppenproduktivität auswirken kann, kann der Lärm im Büro die Produktivität und das Wohlbefinden der einzelnen Mitarbeiter beeinträchtigen. Wie lässt sich das richtige Maß an Privatsphäre schaffen?

Die Verwendung durchdachter schallabsorbierender Möbel ist eine wirksame Methode zur Optimierung der akustischen Eigenschaften eines Raums. Cascandos Privacy- und Akustikmöbel vereinen schönes Design mit hervorragender Abschirmung und eignen sich daher optimal für die akustikfreundliche Einrichtung des Büros. Wir liefern innovative schallabsorbierende Raumteiler und eine Reihe von schallabsorbierenden Wand-, Tisch- und Deckenpaneelen. Nachhaltige Lösungen, die die Atmosphäre am Arbeitsplatz mit Sicherheit verbessern.

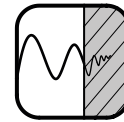

### SOUND ABSORPTION Schallabsorption

Sound absorption can be achieved by applying soft materials with open structures and sufficient thickness. Sound is quickly assimilated by the material and converted into heat, leading to reduced reverberation times. The sound absorption will improve the wellbeing of people using a space.

Durch Verwendung von weichem, offen strukturiertem Material von ausreichender Dicke lässt sich Schall absorbieren. Geräusche werden von einem derartigen Material schnell aufgenommen und in Wärme umgesetzt, was zu kürzeren Nachhallzeiten führt. Das Wohlbefinden der Raumnutzer wird durch die resultierende Schallbegrenzung erheblich verbessert.

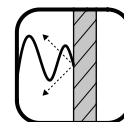

### SOUND ATTENUATION Schallschirmung

Sound attenuation may be accomplished by the use of vertical elements, like space dividers, desk and privacy panels. This technique will isolate sound and prevent the transmission of noise through the space. Sound levels in the space will decrease, while the audibility and clarity of speech improve.

Zur Schallschirmung können vertikale Elemente wie zum Beispiel Raumteiler, Tisch- und Privacy Paneele eingesetzt werden. Geräusch wird dadurch isoliert, während zugleich die Schallübertragung durch die Luft verhindert wird. Der Geräuschpegel im Raum nimmt ab, sodass man besser und deutlicher hören kann, was gesagt wird.

 **More info on:**  
[www.cascando.nl](http://www.cascando.nl)

# Team SPS

DESIGN PETER VAN DE WATER



Team Solid Panel System (SPS) offers high-class privacy and functionality in any space. Team SPS enables you to create seating areas, high and low desks, as well as pantry, print-corner and wardrobe configurations. The solid, lightweight panels are available in various dimensions and offer freedom in design. The series includes matching accessories which can easily be integrated by placing them on the panel. Special colours on request.

Team Solid Panel System (SPS) bietet optimale Privatsphäre und Funktionalität mit Stil. Mit Team SPS kann man Sitzecken, hohe und niedrige Schreibtische, Druckerecken und Garderoben konfigurieren. Die soliden, aber leichten Paneele sind in verschiedenen Abmessungen erhältlich und bieten viel Gestaltungsfreiheit. Die Serie umfasst auch passendes Zubehör, das einfach an den Paneelen angebracht werden kann. Sonderfarben auf Anfrage.

#### MATERIAL

Light weight wooden panel

#### COLOURS PANELS

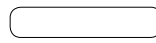

OPAL WHITE



GREY WHITE



OAK

#### DIMENSIONS (CM)

See Team Panel System overview page

#### ADDITIONAL

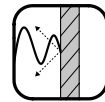

Attenuation



# Team TPS

DESIGN PETER VAN DE WATER

Team Thin Panel System (TPS) offers privacy and comfort in any open space. The primary function of the panels is visual privacy and sound insulation. The thin fabric panels are characterized by soft rounded corners. They are available in various dimensions. Applications: seating, desk, wardrobe, print-corner. With height adjustable feet or plinth.

Team Thin Panel System (TPS) schafft Privatsphäre und Komfort in offenen Raumstrukturen. Die Paneele fungieren in erster Linie als Sichtschutz und als Schalldämmung. Die schlanken Stoffpaneele kennzeichnen sich durch weiche abgerundete Ecken. Sie sind in verschiedenen Abmessungen mit höhenverstellbaren Füßen oder Blende erhältlich. Zum Einsatz kommen sie in Sitzecken, Garderobebereichen, Druckerecken oder zwischen Schreibtischen.



## MATERIAL AND FINISH

Upholstered foam

## FABRICS

Choose from a wide range of fabrics shown in chapter Fabrics

## DIMENSIONS (CM)

See Team Panel System overview page

## ADDITIONAL

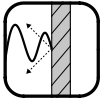

Attenuation







# Team Panel Systems

DESIGN PETER VAN DE WATER

ADDITIONAL

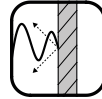

Attenuation

Team Panel Systems SPS and TPS are available in various heights and widths. They can be equipped with several options.

Die Team Paneelsysteme SPS und TPS sind in verschiedenen Größen erhältlich und können mit diversen Zubehören ausgestattet werden.

## DIMENSIONS (CM) (HEIGHT INCLUDES FEET)

### HEIGHT

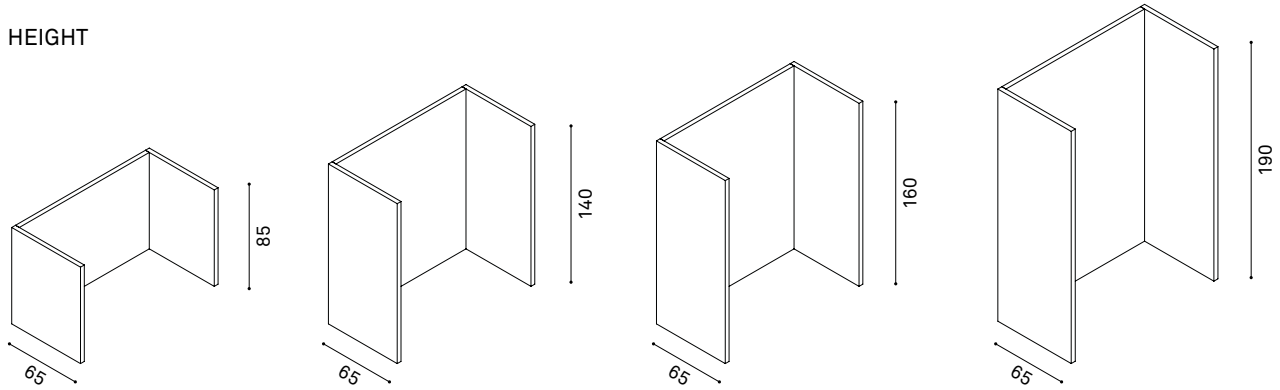

### WIDTH (INTERNAL SIZE)

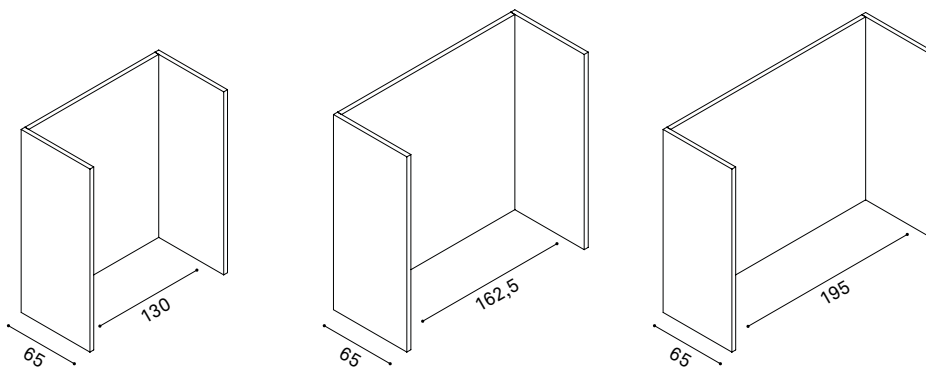

### FUNCTIONS

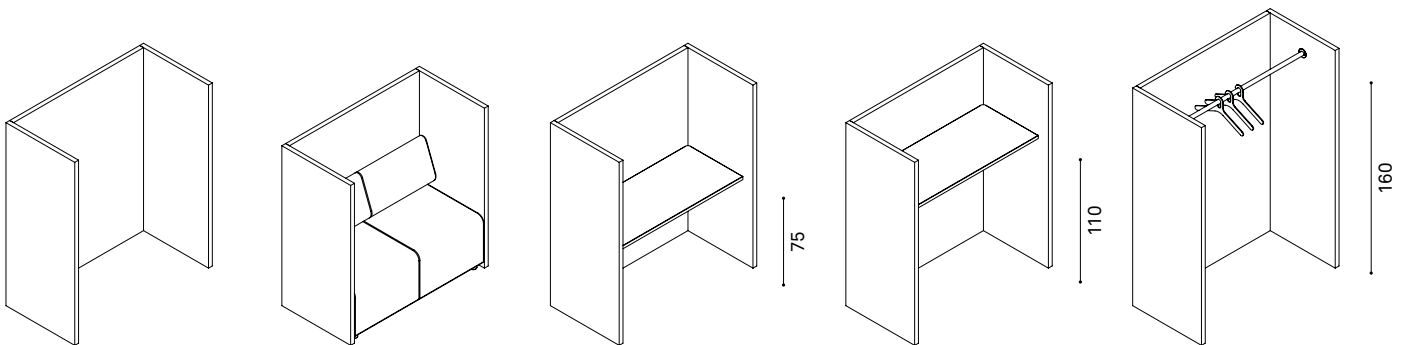

PANTRY / PRINT CORNER

SEATING

LOW DESK

HIGH DESK

WARDROBE

# Pillow Wall

DESIGN ROBERT BRONWASSER







# Pillow Wall

DESIGN ROBERT BRONWASSER

Walls become dynamic shapeshifters and gain attractiveness. The premium acoustic wool adds tranquility to any space. Integrated brochure holders, coat hooks, shelves and memo straps create additional functionality. Pillow Wall; decorative, sound absorbing and functional.

Keine statischen Wände, sondern dynamische, wandlungsfähige und reizvolle Raumteiler. Die hochwertigen, gepolsterten Wandpaneele verwandeln jeden Raum in eine Oase der Ruhe. Integrierte Prospekthalter, Kleiderhaken, Regalbretter und Spannbänder für Memotafeln verwandeln die Paneele in Multifunktionselemente. Pillow Wall – dekorativ, schallabsorbierend und funktional.





# Pillow Wall

DESIGN ROBERT BRONWASSER

A wide range of fabrics, colours, dimensions and functions enables the design of a personal wall for any lobby, hallway, office or meeting room. The panels can be placed adjacent to each other or with some space in between. Pillow Wall panels create spatial intimacy, conveying a homecoming.

Eine breite Auswahl an Stoffen, Farben, Abmessungen und Funktionen ermöglicht den Entwurf persönlicher Trennwände für Empfangsbereiche, Flure, Büros oder Konferenzzimmer. Die Paneele können direkt nebeneinander oder mit etwas Freiraum dazwischen aufgestellt werden. Die Pillow-Wall-Paneele schaffen räumliche Intimität und eine heimelige Atmosphäre.





# Pillow Wall

DESIGN ROBERT BRONWASSER

Think of a Pillow as a beacon. Walls can be changed into a dynamic information centre. Magazines, brochures, maps or private possessions each have their own place on the wall. Every wall is a meeting point.

Nutzen Sie die anziehende Wirkung von Pillow Wall! Mit diesen Wandpaneelen lässt sich ein dynamisches Informationszentrum schaffen. Zeitschriften, Prospekte, Karten und persönliche Gegenstände bekommen alle einen eigenen Platz an der Wand. So ist jede Wand auch Begegnungsort.

## DIMENSIONS & MATERIAL

Pillow Wall information can be found on the Pillow Wall / Pillow Grid overview page.

## ACOUSTIC PROPERTIES

Standard or premium

## FABRICS

Choose from a wide range of fabrics as shown in chapter Fabrics

## ADDITIONAL



Absorption



Attenuation



From live-  
streams, to  
ordering  
straight from  
the runway  
to live soc  
media  
campaigns  
this is the  
latest s  
in a cre  
proces  
will co  
to e

CHRIST  
CCO

Source: The Guardian

# Pillow Grid

DESIGN ROBERT BRONWASSER







# Pillow Grid

DESIGN ROBERT BRONWASSER

Decorative, functional and sound absorbing. Pillow Grid panels have straight corners and can be used on their own or placed in a grid. Adding a memo board, magazine holder, coat rack, shelves and whiteboards in various sizes makes Pillow Grid very functional. Acoustic wool guarantees first class sound absorption.

Dekorativ, funktional und schallabsorbierend. Die rechtwinkligen Pillow-Grid-Paneele können einzeln oder als Teil einer Konstellation verwendet werden. Mit Memotafeln, Prospekthaltern, Kleiderhaken, Regalbrettern und Whiteboards in verschiedenen Größen lässt Pillow Grid sich multifunktional gestalten. Akustische Wolle sorgt für optimale Schallabsorption.





# Pillow Grid

DESIGN ROBERT BRONWASSER

The straight corners of the Pillow Grid panels enable the creation of both small and large wall designs. And with an increased range of sizes, accessories, fabrics and colours, Pillow Grid walls become a central design element in any interior.

Dank ihrer rechten Winkel und geraden Kanten kann man mit den Pillow-Grid-Paneeelen sowohl kleine als große Wandkonfigurationen mühelos zusammenstellen. Die jetzt noch größere Auswahl an Größen, Zubehör, Stoffen und Farben garantiert, dass eine Pillow-Grid-Wand in jeder Einrichtung zum Blickfänger wird.





*Maisons*  
**CÔTE SUD**  
MARS-JUILLET 2011 / BIMESTRIEL 6 € [www.cotemoison.fr](http://www.cotemoison.fr)



**S, PORQUEROLLES...**

Abonnement 607 10014630 / BELGIUM 0111187 / A. G. 40 / AND. C. 14188300 / A. 1100 / ESP. C. 65111111  
FR. C. 30 / ILL. 630 / IT. C. 670 / MAL. 2010 / MEX. C. 125 / NOR. C. 977 / POL. 1100 / PORT. C. 311 / RUS. 1100

# Pillow Grid

DESIGN ROBERT BRONWASSER

Memos, magazines, plants and objects can be placed on the wall. Pillow Grid whiteboards in various sizes become part of the design. Every wall is a meeting point and adds tranquility to the space.

Notizzettel, Zeitschriften, Pflanzen und Objekte finden einen Platz an der Wand. Pillow-Grid-Whiteboards in verschiedenen Größen werden Bestandteil des Designs. Jede Wand ist ein Begegnungsort und bringt Ruhe in den Raum.

## DIMENSIONS & MATERIAL

Pillow Grid information can be found on the Pillow Wall / Pillow Grid overview page.

## ACOUSTIC PROPERTIES

Standard or premium

## FABRICS

Choose from a wide range of fabrics as shown in chapter Fabrics

## ADDITIONAL



Absorption

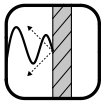

Attenuation



# SUSPENSION

PANELS 40X80

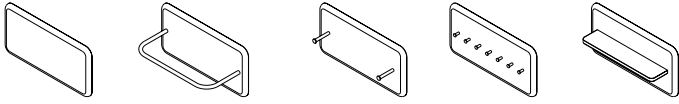

PANELS 80X40

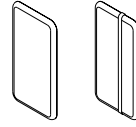

PANELS 80X80

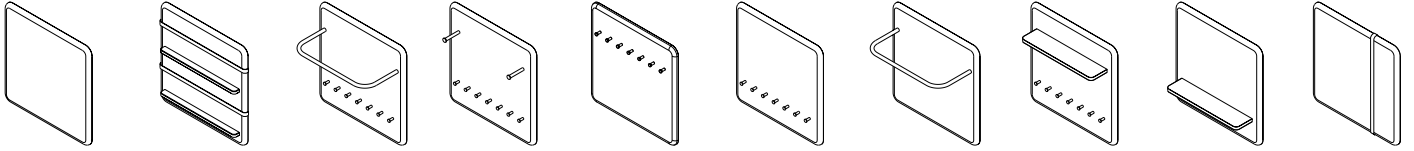

PANELS 120X80

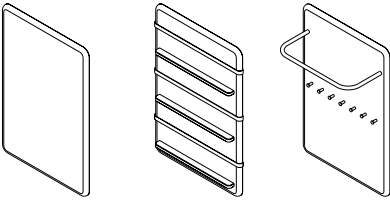

PANELS 160X80

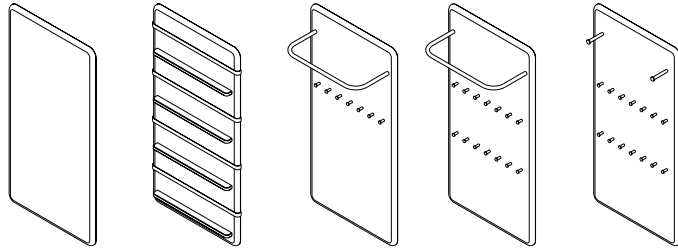

PANELS 80X160

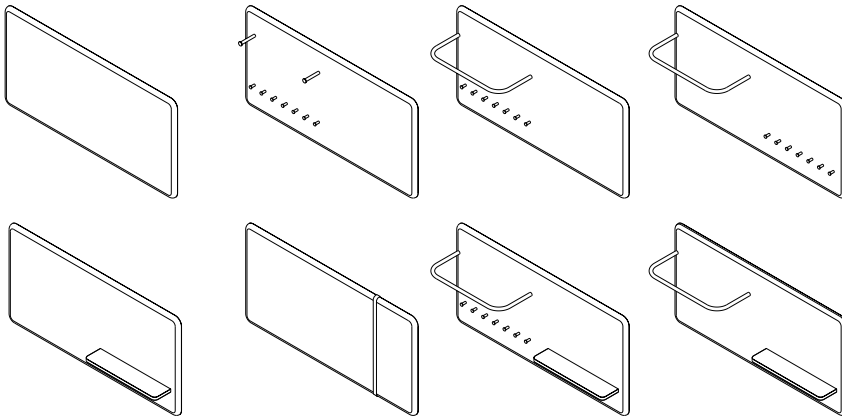

PANEL 80X120

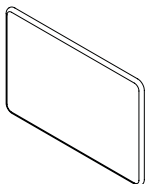

PANEL 120X120

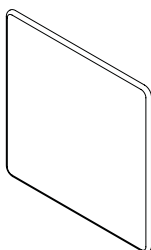

PANEL 160X160

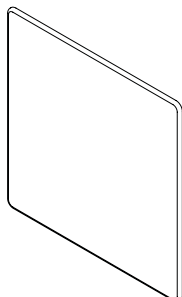

WHITEBOARD PANELS (PILLOW GRID)

80X80

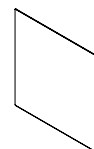

120X80 - 80X120



160X80 - 80X160

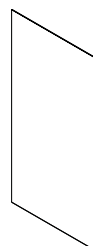

# Pillow Wall & Pillow Grid

DESIGN ROBERT BRONWASSER

Wall panels with rounded or straight corners, available with various functional accessories and standard or premium sound absorption. For panels with accessories please always choose standard acoustic panels. Premium acoustic panels should be applied without panel accessories. Standard acoustic panels thickness is 3 cm, premium acoustic panels thickness is 6 cm.

Wandpaneel mit abgerundeten oder scharfen Ecken, lieferbar mit verschiedenen funktionellen Accessoires, in der akustischen Klasse Standard oder Premium. Für Paneel mit Accessoires bitten wir Sie, immer Standard Akustik zu wählen. Paneel mit Premium Akustik sollten immer ohne Accessoires eingeplant werden. Standard akustische Paneel sind 3 cm tief, Premium akustische Paneel sind 6 cm tief.

**MATERIAL**  
Upholstered foam

**FABRICS**  
Choose from a wide range of fabrics shown in chapter Fabrics

## FUNCTIONS

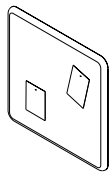

PINBOARD

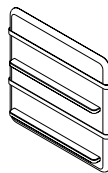

MAGAZINE HOLDERS  
(D=55 MM)

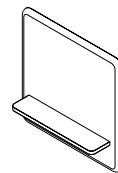

SHELVE  
( D=15 CM)

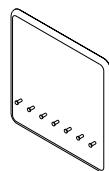

COAT HOOKS

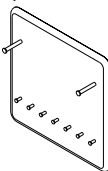

COAT HOOKS

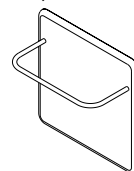

COAT RACK

## SUSPENSION

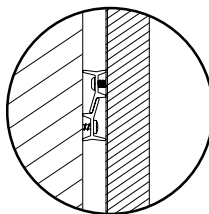

**ACOUSTIC PROPERTIES**  
Standard or premium

**FABRICS**  
Choose from a wide range of fabrics shown in chapter Fabrics

**ADDITIONAL**  
Matching coat hanger: Pole hanger  
Brochure holder depth: 55 mm



Absorption

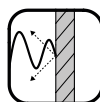

Attenuation



# Pillow Round

DESIGN ROBERT BRONWASSER

Pillow Wall panels are also available in round designs. Three different diameters allow the creation of sound-absorbing wall designs for an entrance, lobby or office. Distance holders allow the panels to overlap. Standard or premium acoustic properties.

Die Pillow-Wall-Paneele sind auch in runder Ausführung in drei verschiedenen Durchmessern erhältlich. So lassen sich schallabsorbierende Entwürfe für Wände in Eingangsbereichen, Begegnungsbereichen und Büros schaffen. Abstandhalter ermöglichen eine überlappende Anordnung. In zwei Absorberqualitäten – Standard und Premium – erhältlich.



**MATERIAL AND FINISH**

Upholstered foam

**ACOUSTIC PROPERTIES**

Standard or premium

**FABRICS**

Choose from a wide range of fabrics shown in chapter Fabrics

**DIMENSIONS (CM)**

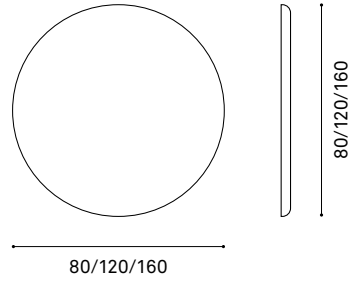

**ADDITIONAL**

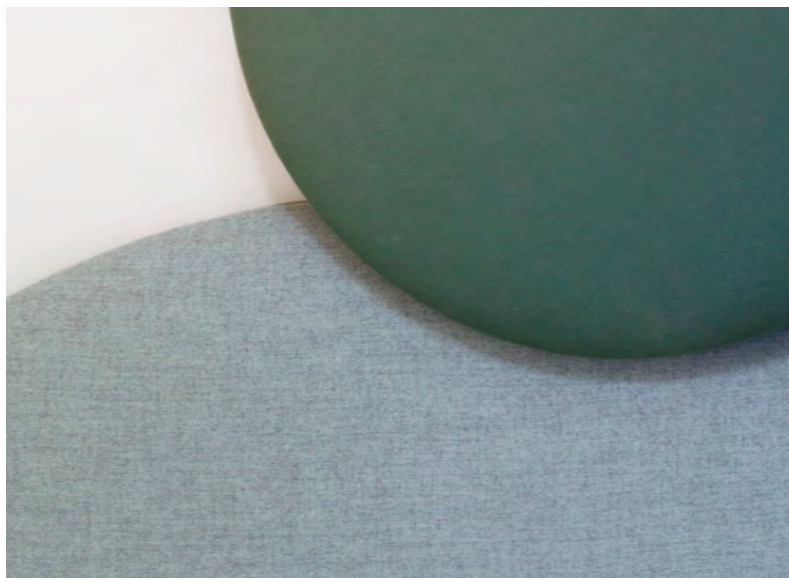
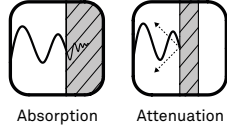

# Pillow Desk

DESIGN ROBERT BRONWASSER

In modern and open offices privacy and concentration are matters of importance. Pillow Desk panels have been developed for flexible use in open spaces. Equipped with slim feet, they can be placed free standing on any desk offering visual privacy and sound isolation. They can also be removed easily, bringing back transparency when desired. Pillow Desk panels can also be fix mounted on, or to, a desk. Magnetic feet are an option as well.

In modernen Großraumbüros sind Privatsphäre und Konzentrationsfähigkeit wichtige Aspekte. Die Pillow-Desk-Paneele wurden speziell zum flexiblen Einsatz in derartigen offenen Räumen entwickelt. Die Paneele haben schlanke Füße und können freistehend auf jedem Büro als Sichtschutz und Schallschirm positioniert werden. Bei Bedarf an mehr Kontakt lassen sie sich auch leicht wieder entfernen. Die Pillow-Desk-Paneele können auch fest an oder auf dem Schreibtisch montiert werden. Magnetische Füße sind auch möglich.



**MATERIAL AND FINISH**

Upholstered wooden panel  
Powder coated steel base

**COLOUR BASE**



GREY WHITE

**ACOUSTIC PROPERTIES**

Standard or premium

**FABRICS**

Choose from a wide range of fabrics shown in chapter Fabrics

**DIMENSIONS (CM)**

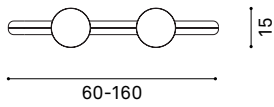

\* height dimensions are without base

**ADDITIONAL**

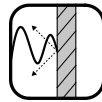

Attenuation





# Pillow Free

DESIGN ROBERT BRONWASSER

Ceilings have been proven to be very efficient areas for sound absorption. Pillow Free panels offer decorative and sound absorbing solutions for ceilings. They are available in round and square designs, both in various sizes. The top is covered with a black fabric or with panel fabric on request. LED lighting can be integrated. Suspension cables with height adjustment are also included.

Das Anbringen von Schallabsorbern an der Decke hat sich als besonders wirksam erwiesen. Pillow-Free-Paneele sind dekorative akustische Deckensegel. Sie sind, sowohl rund als eckig ausgeführt, in verschiedenen Größen erhältlich. Der Rücken ist mit schwarzem Stoff bezogen. Auf Anfrage kann auch der Paneelstoff verwendet werden. Der Einbau von LED-Lampen ist ebenfalls möglich. Ein höhenverstellbares Aufhängesystem ist einbegriffen.



## MATERIAL AND FINISH

Upholstered wooden panel

## ACOUSTIC PROPERTIES

Standard or premium

## FABRICS

Choose from a wide range of fabrics shown in chapter Fabrics

## DIMENSIONS (CM)

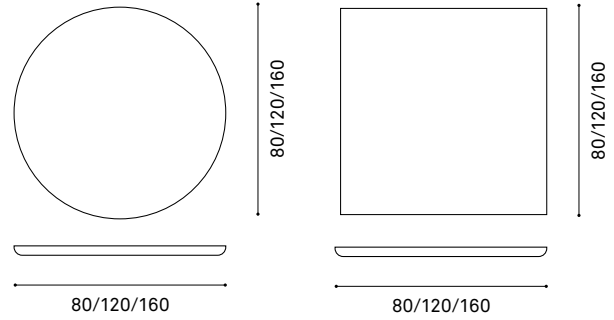

## ADDITIONAL

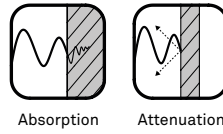

Absorption

Attenuation



# Pillow Space

DESIGN ROBERT BRONWASSER







# Pillow Space

DESIGN ROBERT BRONWASSER

Pillow Space is a series of acoustic space dividers with an unprecedented performance. They provide visual privacy, sound absorption and a high level of functionality to any open space. Standard or premium acoustic wool guarantees optimal sound absorption in any situation. Equipped with casters and brakes, the elements are mobile and flexible.

Pillow Space ist eine Reihe extrem leistungsfähiger, akustischer Raumteiler. In großräumigen Umgebungen dienen sie als Sichtschutz, Schalabsorber und Multifunktionselement. Die Wolle in Standard- oder Premium-Qualität garantiert, dass Geräusche in jeder Situation optimal absorbiert werden. Rollen mit Bremsen verleihen den Elementen Mobilität und Flexibilität.



# Pillow Space

DESIGN ROBERT BRONWASSER

Pillow Space can be equipped with many functions. For example, whiteboards, LCD screens, coat hooks and brochure holders can be mounted on the outside. On the inside (in the space between the panels), shelves, displays, wardrobe, drawers and lockers can be placed. There is even a planter version. Pillow Space is available in various heights and widths.

Pillow Space lässt sich mit vielen Funktionen ausstatten. Auf der Außenseite können die Paneele zum Beispiel mit Whiteboards, LCD-Bildschirmen, Kleiderhaken und Prospekthaltern ausgestattet werden. Auf der Innenseite (zwischen den Paneelen) können Regalbretter, Prospektablagen, Garderobenstangen, Schubladen oder Schließfächer angebracht werden. Es gibt sogar eine Version mit einem integrierten Pflanzengefäß. Pillow Space ist in verschiedenen Höhen- und Breitenmaßen erhältlich.









esperé

|             |    |
|-------------|----|
| VIKENDAG :  | X  |
| DINSDAG :   | —  |
| WOENSDAG :  | X  |
| DONDERDAG : | XX |
| VRIDAG :    | —  |

# Pillow Space

DESIGN ROBERT BRONWASSER

Mobile space dividers; available with various functional accessories and standard or premium sound absorption. Note: for panels with accessories please always choose standard acoustic panels. Premium acoustic panels should be applied without panel accessories.

Mobile Raumteiler, lieferbar mit verschiedenen funktionellen Accessoires, in der akustischen Klasse Standard oder Premium. Achtung: für Paneele mit Accessoires bitten wir Sie, immer Standard Akustik zu wählen. Paneele mit Premium Akustik sollten immer ohne Accessoires eingeplant werden.

## MATERIAL AND FINISH

Powder coated aluminium and steel  
Upholstered foam  
Shelves in MDF or natural oak

## ACOUSTIC PROPERTIES

Standard or premium

## FABRICS

Choose from a wide range of fabrics shown in chapter Fabrics

## ADDITIONAL

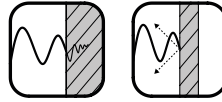

Absorption

Attenuation



## DIMENSIONS (CM)

### WIDTH

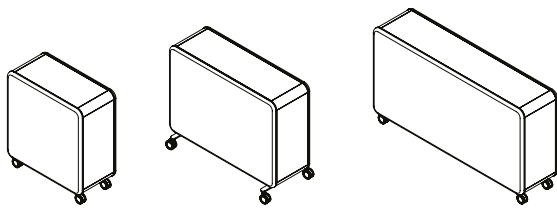

79

113

160

### HEIGHT

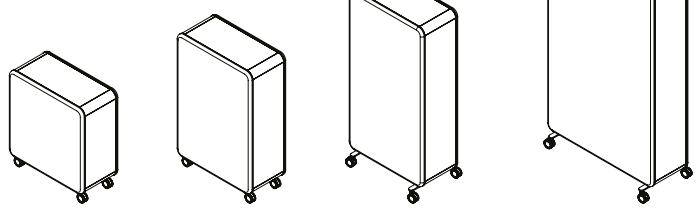

89

123

159

193

## OPTIONS

### INSIDE

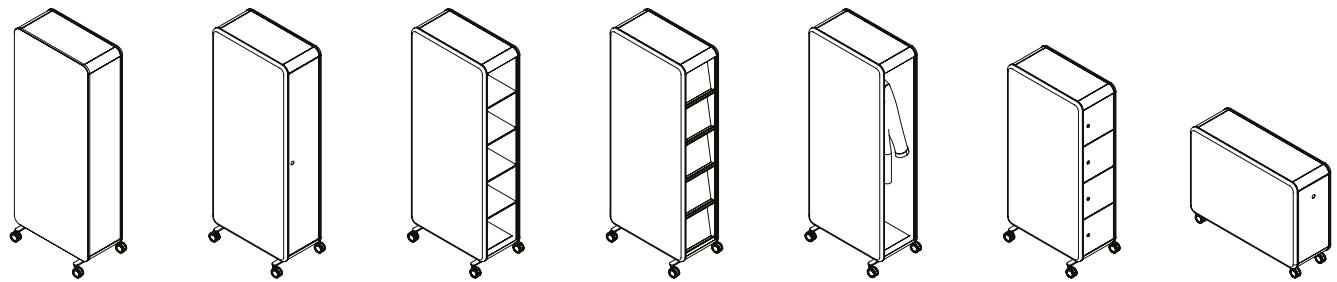

closed

door

shelves

brochure holder  
/ storage

wardrobe

lockers

drawer

### PANEL SIDE

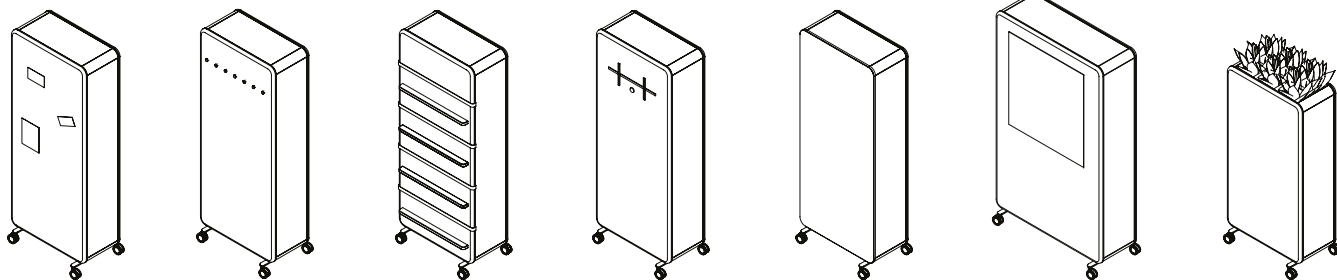

pinboard

coat hooks

brochure shelves

screen support

whiteboard

whiteboard glass

planter



# Round20 Acoustic

DESIGN ROBERT BRONWASSER

The acoustic panels can be used as a memo panel and can be combined with a whiteboard panel on the other side. Multifunctional and mobile. Available with standard foam or premium acoustic wool for first-class sound absorption. The frames are available in wood and aluminium. The panels and whiteboards come in various widths.

Die mit Stoff bezogenen akustischen Paneele können als Memotafel verwendet werden. Auf der anderen Seite kann bei Bedarf ein Whiteboard angebracht werden. Diese multifunktionalen mobilen Elemente sind mit Standard- oder Premium-Wolle für optimale Schallabsorption erhältlich. Die Paneelrahmen können aus Holz oder Aluminium ausgeführt werden. Die Paneele und Whiteboards sind in verschiedenen Breitenmaßen erhältlich.



## MATERIAL AND FINISH ROUND20 WOOD

Wooden frame with casters and brakes  
Aluminium bar

## COLOURS ROUND20 WOOD

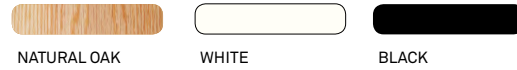

## DIMENSIONS (CM)

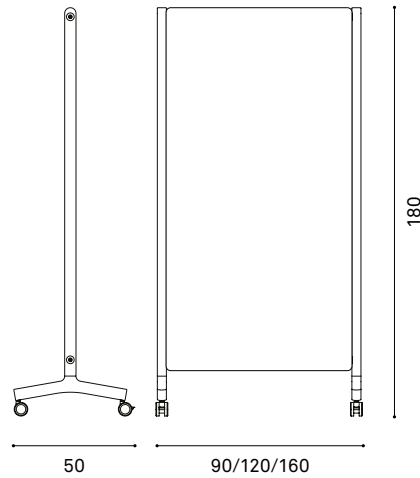

## ADDITIONAL

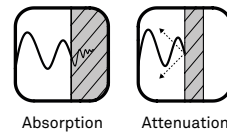

# Trunk

DESIGN ROBERT BRONWASSER

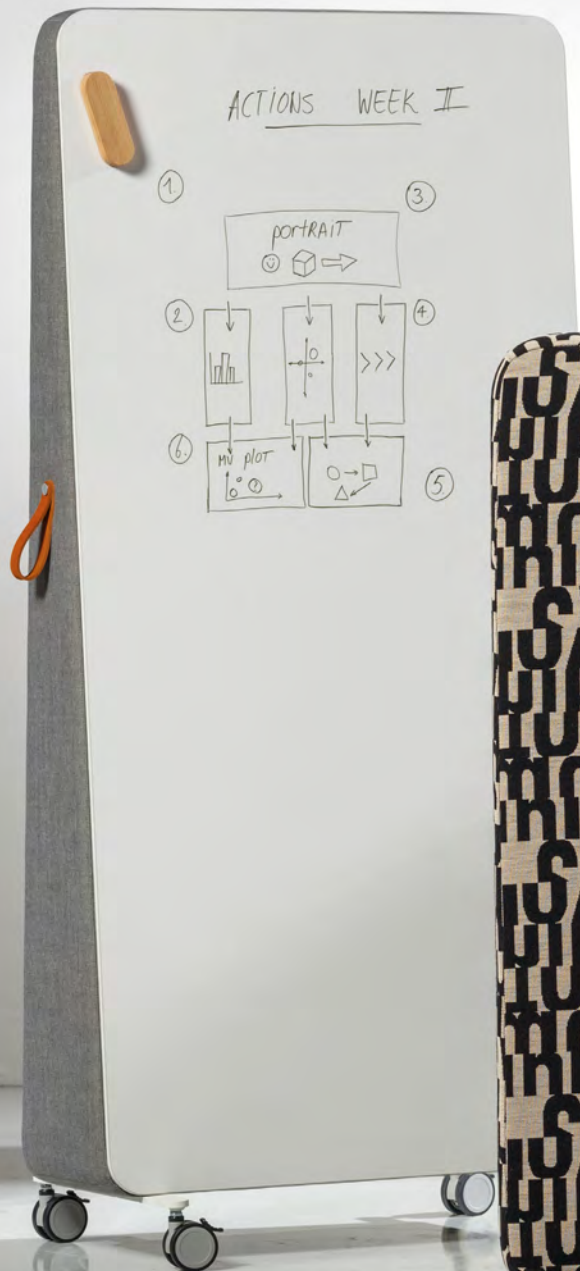





# Trunk

DESIGN ROBERT BRONWASSER

Trunk is a series of mobile and acoustic space dividers. The mobile whiteboard or LCD Trunks enable presentations to customers and colleagues. The leather handle makes it easy to move around.

Trunk ist eine Reihe mobiler akustischer Raumteiler. Die verfahrenbaren Whiteboard- oder LCD-Versionen eignen sich gut für Präsentationen an Kunden und Kollegen. Mithilfe von Ledergriffen können die Elemente leicht bewegt werden.







Arter Allgemeine

# Trunk

DESIGN ROBERT BRONWASSER

Trunk can hold memos, magazines and jackets. It's a stylish and multifunctional tool for any workplace or meeting room. Premium acoustic wool (option) offers first class sound-absorbing properties. Trunk comes in various heights and widths. Casters with brakes are standard.

An Trunk kann man Notizzettel, Zeitschriften und Jacken aufhängen. Ein multifunktionaler, stilvoller Raumteiler für jedes Büro oder Konferenzzimmer. Die Premium Wolle (optional) bietet erstklassige Schallabsorption. Trunk ist in verschiedenen Höhen und Breiten erhältlich. Rollen mit Bremsen gehören zur Standardausstattung.



## MATERIAL AND FINISH

Upholstered foam

## FABRICS

Choose from a wide range of fabrics shown in chapter Fabrics

## ACOUSTIC PROPERTIES

Standard or premium

## DIMENSIONS (CM)

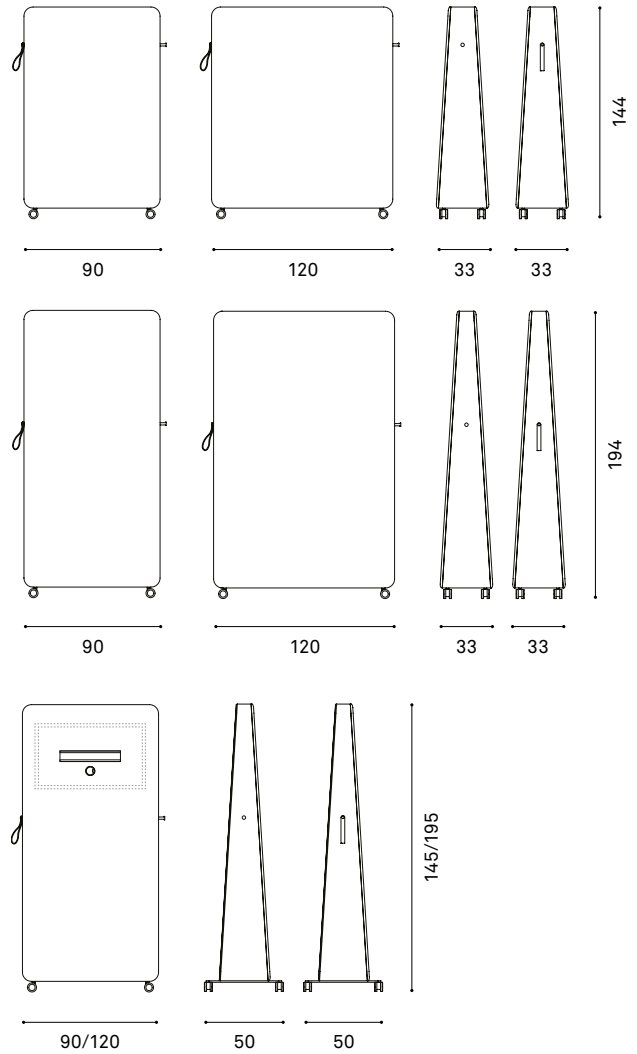

## ADDITIONAL

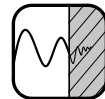

Absorption

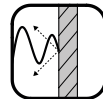

Attenuation



# Trunk Desk

DESIGN ROBERT BRONWASSER

Compared to traditional fix-mounted desk-top screens, Trunk offers a flexible way to create privacy. When you need to concentrate, just place Trunk on your desk. And when you want to open up your workspace again, you simply put it back on the floor. In both cases, Trunk will also hold memos, magazines and personal belongings.

Anders als herkömmliche, fest montierte Schreibtischpaneele schafft Trunk Privatsphäre mit Flexibilität. Wenn Sie sich konzentrieren müssen, stellen Sie Trunk einfach auf. Haben Sie wieder Bedarf an mehr Offenheit, stellen Sie Ihren Trunk einfach zurück auf den Boden. In beiden Fällen bewahrt Trunk Notizzettel, Zeitschriften und persönliche Gegenstände für Sie auf.

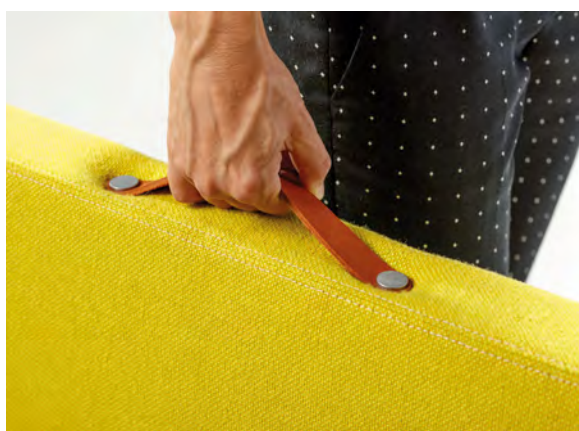

## MATERIAL AND FINISH

Upholstered foam

Leather handle

## FABRICS

Choose from a wide range of fabrics shown in chapter Fabrics

## DIMENSIONS (CM)

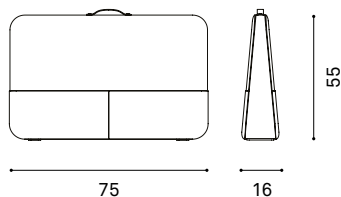

## ADDITIONAL

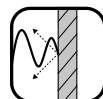

Attenuation



# Coat stands

P. 100-133

# Flower

DESIGN ROBERT BRONWASSER

Beautifully lined wardrobe crown with large and smaller loop hooks for at least ten coats. The heavy cast iron base and steel upright ensure optimal stability. Flower is available in eight contemporary colours.

Wunderschön entworfene Garderobekrone mit großen Schlaufen und kleinen Haken für mindestens zehn Mäntel. Der schwere gusseiserne Fuß sorgt für optimale Stabilität. Flower ist in acht modernen Farben erhältlich.







# Flower Plus

DESIGN ROBERT BRONWASSER

The price winning coat stand as shown on the previous page, extended with an integrated umbrella holder. The Flower Plus is suitable for ten jackets and over four umbrellas. Large umbrellas can be placed inside the flower-leaves, smaller ones can be hung on the smaller loop hooks.

Der auf der vorherigen Seite gezeigte preisgekrönte Garderobenständer, aber um einen integrierten Schirmhalter ergänzt. Der Flower Plus eignet sich für zehn Jacken und mehr als vier Regenschirme. Große Schirme können in die Blätter gestellt werden, kleinere kann man an den kleineren Haken aufhängen.



## MATERIAL AND FINISH

Polyamide crown  
Powder-coated steel tube  
Cast iron base

## COLOURS



## DIMENSIONS (CM)

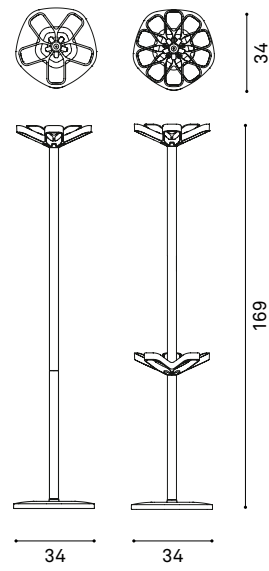



# Standfree

DESIGN ONNO DE KNEGT

Standfree is a stylish eye-catcher. The symmetrical shape and polished aluminium accents give the coat stand a formal, well-presented appearance. The steel base ensures optimal stability.

Standfree ist ein stilvoller Blickfang. Die symmetrische Form und die Akzente aus poliertem Aluminium geben dem Garderobenständer eine formelle, repräsentative Ausstrahlung. Die Fertigung aus Stahl sorgt für optimale Stabilität.

## MATERIAL AND FINISH

Powder coated aluminium upright  
Polished aluminium horizontal bar  
Powder coated steel base

## COLOURS BASE & UPRIGHT



## COLOURS HORIZONTAL BARS

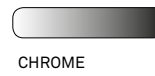

## DIMENSIONS (CM)



## ADDITIONAL

Matching coat hanger: Chrome hanger

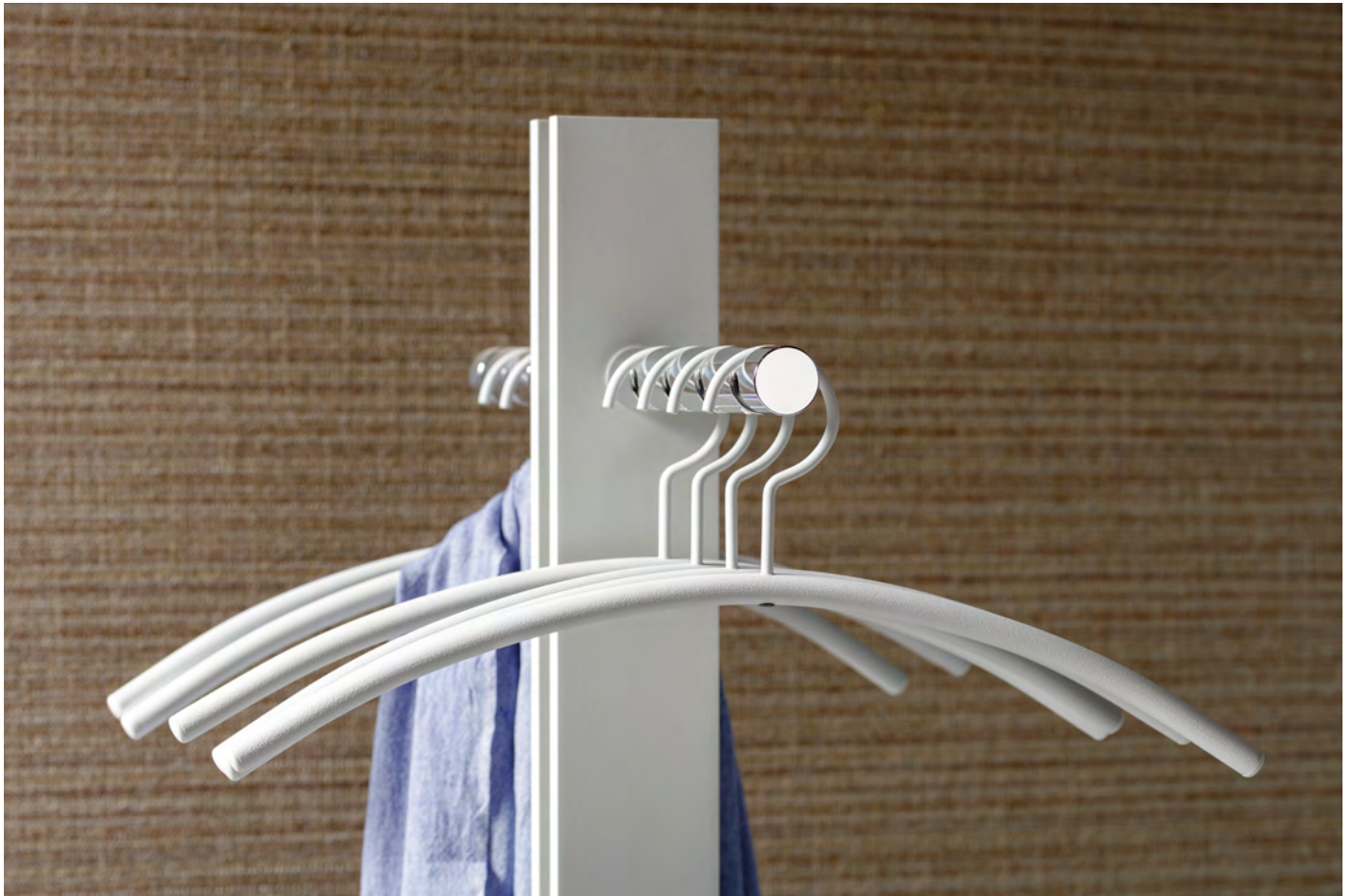

# Standfree Wood

DESIGN ONNO DE KNEGT

Oak wood uprights can be combined with hangers and base plate in white or black. Another combination is oak with polished aluminium hangers and an aluminium coloured base plate.

Ständer aus Eichenholz lassen sich mit Stangen und Fussplatte in Weiß oder Schwarz kombinieren. Eine andere Kombination ist Eiche mit polierten Aluminium Stangen.

## MATERIAL AND FINISH

Oak, aluminium, steel

## COLOURS METAL PARTS



## DIMENSIONS (CM)

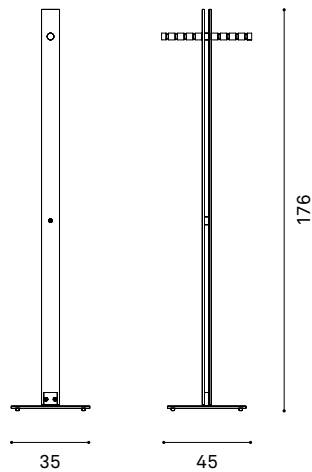

# Standfree-P

DESIGN ONNO DE KNEGT

Standfree can be equipped with a umbrella holder and raindrip.  
The magnetic rubber raindrip can easily be removed for cleaning.

Standfree kann mit einem Schirmhalter und Tropfschale geliefert werden. Die magnetische Tropfschale aus Gummi kann einfach zum Reinigen entfernt werden.

## MATERIAL AND FINISH

Powder coated aluminium upright

Polished aluminium horizontal bar

Powder coated steel base

## COLOURS

See Standfree on previous page

## DIMENSIONS (CM)

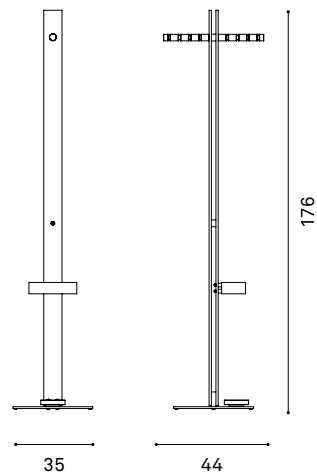



# Standalone

DESIGN ONNO DE KNEGT & TONNY VAN DEIJNEN

The Standalone coat stand simply leans against the wall. The curved shape of the upright and the rubber sleeves at the base create perfect stability. The grooved horizontal bar of polished aluminium accommodates five coat hangers.

Dieser Garderobenständer lehnt einfach gegen die Wand. Die gebogene Form des Ständers und die schwarzen Bodenmanschetten aus Gummi bieten perfekte Stabilität. Die mit Rillen versehene Garderobenstange aus poliertem Aluminium bietet Platz für fünf Kleiderbügel.



## MATERIAL AND FINISH

Powder coated aluminium upright  
Polished aluminium horizontal bar and foot  
Rubber sleeved base

## COLOUR



ALUMINIUM

## DIMENSIONS (CM)

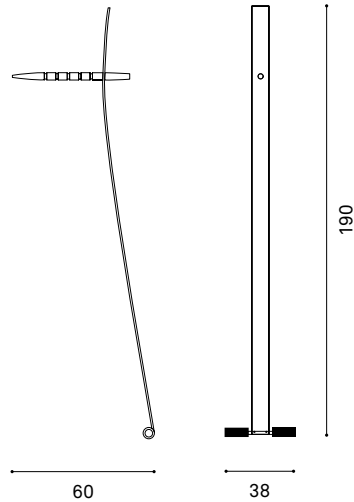

## ADDITIONAL

Matching hanger: Chrome hanger





# Flow Square

DESIGN MARLEEN VALSTAR

With eight large hooks above and small hooks below, the Flow Square is attractive, yet highly practical. The crown and stable steel base are coated in white while the pole comes in chrome.

Durch die acht großen Haken mit kleinen Häkchen darunter ist Flow Square attraktiv und zugleich sehr praktisch. Die Krone und der stabile Fuß aus Stahl sind weiß lackiert. Das Rohr ist in glänzendem Chrom ausgeführt.



## MATERIAL AND FINISH

Powder coated crown  
Gloss chrome upright  
Powder coated steel base

## COLOUR BASE



TRAFFIC WHITE

## COLOUR CROWN



TRAFFIC WHITE

## DIMENSIONS (CM)

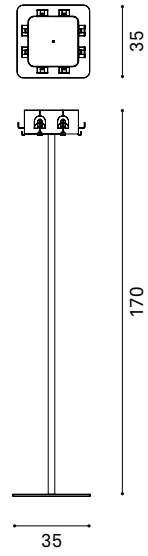



# Basket

DESIGN PETER VAN DE WATER

Basket is made from steel wires, woven together using industrial craftsmanship. The wires form a symmetrical pentagon at the base. A practical coat stand, but above all a timeless and architectural object.

Basket besteht aus Stahldrähten, fachmännisch industriell ineinander verwoben. Die Drähte bilden an der Basis ein symmetrisches Fünfeck. Ein praktischer Garderobenständer, aber vor allem ein zeitloses und architektonisches Objekt.

## MATERIAL AND FINISH

Powder coated steel frame

## COLOURS



TRAFFIC WHITE



TRAFFIC BLACK

## DIMENSIONS (CM)

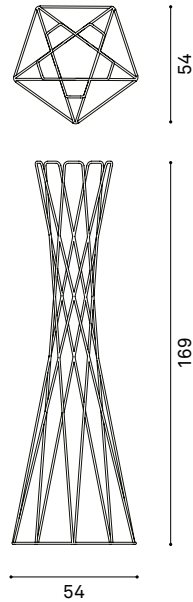



# Twist

DESIGN ROBERT BRONWASSER

Twist is made of bamboo and is available in two models, each containing nine coat hooks. One version is elegantly standing on its triple poles and has a round bamboo shelf on top. The other one uses the bamboo plate as a solid base, while the three poles are freely standing up.

Twist ist aus Bambus gefertigt und in zwei Modellen erhältlich. Jedes Modell ist mit neun Kleiderhaken versehen. Eine Ausführung steht elegant auf drei Stäben und hat eine runde Bambus Platte auf der Oberseite. Das andere Model verwendet die Bambus Platte als solide Basis, während die drei Stäbe frei nach oben stehen.

## MATERIAL AND FINISH

Bamboo

Stainless steel

## DIMENSIONS (CM)

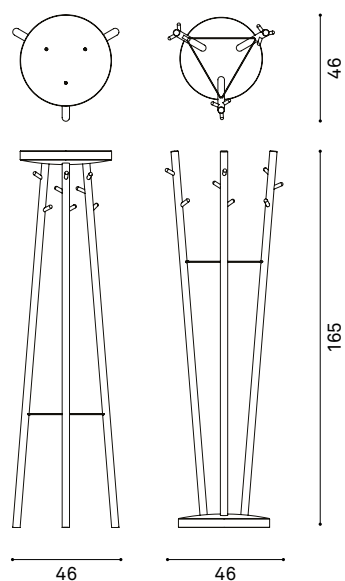

# Tree

DESIGN ROBERT BRONWASSER

The Tree coat stand forms part of Cascando's Nature series: a range of light-hearted elements. Tree is a stable, freestanding coat stand which can hold as many as 20 coats. Made of lacquered MDF with pegs in white grey.

Der Tree Garderobenständer ist Teil der Nature-Serie von Cascando: eine Reihe spielerischer Elemente. Tree ist ein stabiler, frei stehender Kleiderständer, der Platz für mindestens 20 Mäntel bietet. Hergestellt aus lackiertem MDF, mit Knöpfen in Weiß Grau.



## MATERIAL AND FINISH

Lacquered MDF  
Pegs in grey white

## COLOURS



TRAFFIC WHITE



OLIVE GREEN



WARM GREY

## DIMENSIONS (CM)

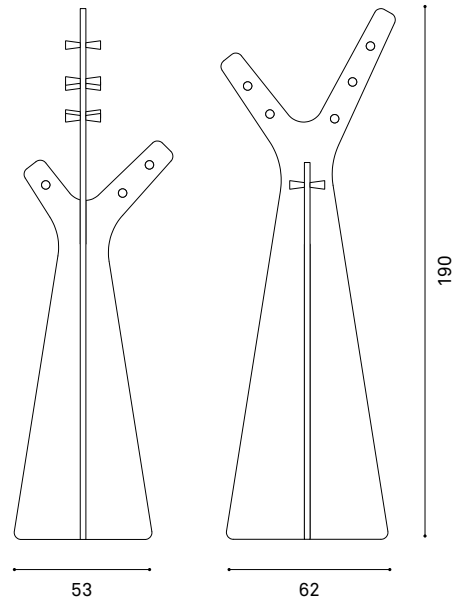



# Bamboo

DESIGN PETER VAN DE WATER

A single bamboo upright or a set of three, steadily mounted in a steel base. The five hooks on each upright can easily be adjusted by sliding the hook upwards, adjusting the rubber O-ring and clicking the hook back into position.

Eine einziger Bambus Ständer oder einen Satz von drei, stetig in einem stählernem Fuß montiert. Die fünf Haken an jedem Ständer können leicht angepasst werden, indem Sie den Haken nach oben schieben, den Gummi O-Ring verstellen und den Haken wieder in seine Position zurück klicken.



## MATERIAL AND FINISH

Bamboo upright

Polyamide hooks

Powder coated steel base

## COLOUR HOOKS AND BASE



TRAFFIC WHITE

## DIMENSIONS (CM)

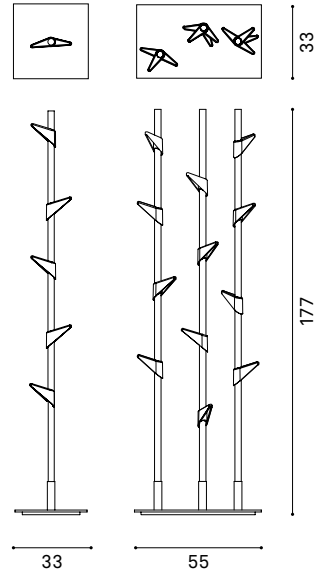

# Bamboo Steel

DESIGN PETER VAN DE WATER

The colorful steel version of Bamboo. Play with the colours and varieties to create the optimal wardrobe for your project. By sliding the hook upwards, adjusting the rubber O-ring and clicking the hook back into position, you can easily adjust the five hooks on each upright.

Die bunten Ausführungen des Bamboos aus Stahl. Spielen Sie mit den Farben und Ausführungen, um die optimale Garderobe für Ihr Projekt zu entwerfen. Indem Sie den Haken nach oben schieben, den Gummi O-Ring nach Wunsch versetzen und den Haken wieder in seine Position zurück klicken, können die fünf Haken an jedem Ständer leicht verstellt werden.



**MATERIAL AND FINISH**  
 Powder coated steel upright  
 Polyamide hooks  
 Powder coated steel base

**COLOURS UPRIGHT**

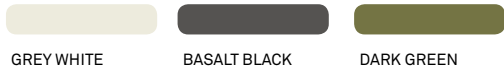

**COLOURS HOOKS**



**DIMENSIONS (CM)**

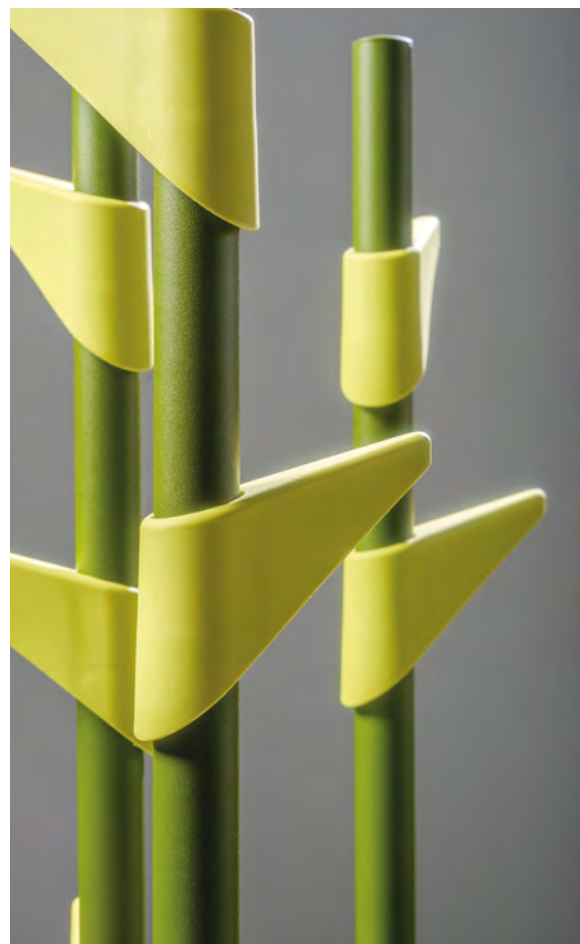
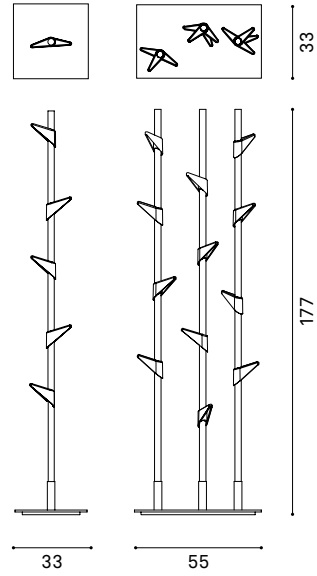



# Bend

DESIGN PETER VAN DE WATER

Bend consists of bent metal uprights which are elegantly connected by polished aluminium pegs. Coats can be hung on the carefully rounded ends of the strips or on the tree pegs. Bend is available in fresh white, cheerful yellow and rugged grey.

Bend besteht aus gebogenen Metallstreifen, die elegant mit polierten Aluminiumknöpfen verbunden sind. Die Mäntel werden über das sorgfältig abgerundete Ende des Streifens oder an die polierten Aluminiumknöpfe gehängt. Bend ist in frischem Weiß, fröhlichem Gelb und solidem Grau erhältlich.

## MATERIAL AND FINISH

Powder coated steel frame  
Polished aluminium pegs

## COLOURS



TRAFFIC WHITE



SIGNAL YELLOW



BASALT GREY

## DIMENSIONS (CM)

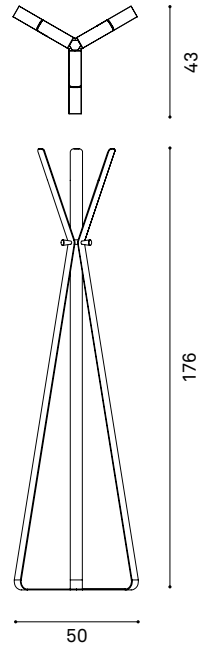

# Pole

DESIGN ROBERT BRONWASSER

Pole is a robust, yet friendly steel coat stand. The separately available matching coat hangers can hold eight to ten coats. Play with the four available powder coatings, to give Pole a completely different look: from fresh and cheerful to minimalist and elegant.

Pole ist ein robuster, aber freundlicher Garderobenständer aus Stahl. Die separat erhältlichen, dazu passenden, Kleiderbügel sind zum Aufhängen von acht bis zehn Mäntel geeignet. Spielen Sie mit den vier verfügbaren Pulverlackierungen, um Pole ein völlig anderes Erscheinungsbild zu verleihen: von frisch und fröhlich zu minimalistisch und elegant.



**MATERIAL AND FINISH**  
Powder coated steel base  
Powder coated steel upright

**COLOURS**

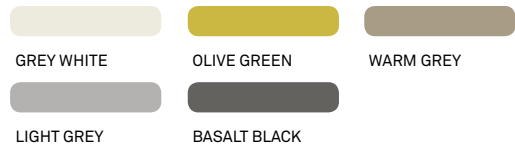

**DIMENSIONS (CM)**

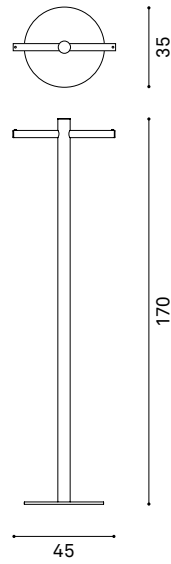

**ADDITIONAL**  
Matching coat hanger: Pole hanger







# Velvet

DESIGN MARLEEN VALSTAR

The Velvet stands out by its striking polyamide pegs in three colours. The designer coat stand comes with three, four or five arms, each equipped with two additional hooks for extra capacity. Also an umbrella stand can be integrated. The top and frame are made of anodized aluminium, the subtle foot was created of steel.

Velvet zeichnet sich durch seine markanten, in drei Farben erhältlichen Polyamidknöpfe aus. Der Design-Garderobenständer ist nach Wahl mit drei, vier oder fünf Armen ausgestattet. Jeder dieser Arme ist mit zwei Haken versehen, um zusätzlichen Platz zu bieten. Der Velvet ist mit oder ohne Schirmständer lieferbar. Die Krone und der Steher sind aus eloxiertem Aluminium gefertigt, der subtile Fuß aus Stahl.



## MATERIAL AND FINISH

Polyamide pegs

Anodized aluminium crown and frame

Steel base

## COLOURS



ORANGE



WHITE



BLACK

## DIMENSIONS (CM)

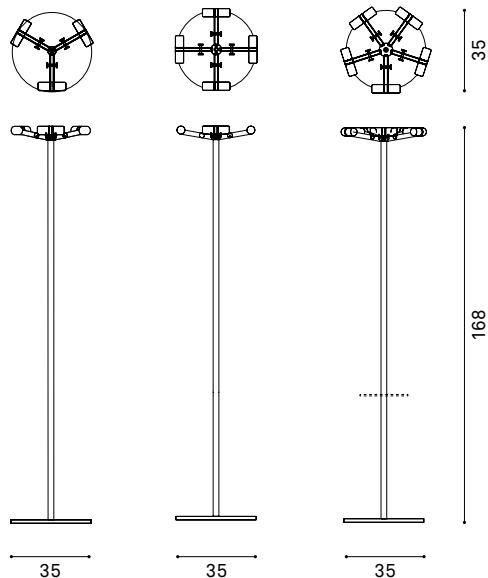



# Coat Lamp

DESIGN ROBERT BRONWASSER

At first glance this appears to be a lamp, but closer inspection reveals a coat stand which can hold eight coats. Coat Lamp is made of anodised aluminium and steel. The shade comes in black or white, but can also be supplied in other colours on request. Available with or without integrated lighting.

Auf den ersten Blick eine Lampe, auf den zweiten ein Garderobenständer, der Platz für acht Jacken bietet. Coat Lamp ist aus eloxiertem Aluminium und Stahl gefertigt. Der Schirm ist in Schwarz, Weiß oder auf Anfrage auch in anderen Farben lieferbar und mit oder ohne integrierter Beleuchtung erhältlich.

## MATERIAL AND FINISH

Anodized aluminium upright  
Cloth shade  
Steel base

## COLOURS SHADE



## DIMENSIONS (CM)

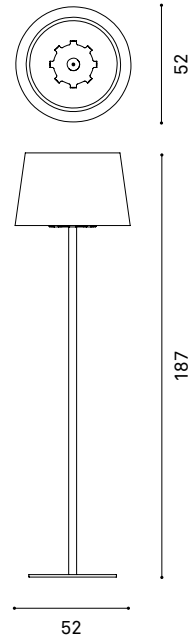



# Tango

DESIGN MINKE VAN VOORTHUIZEN

The crown of the Tango is made of high-gloss polished aluminium. The slender cast iron base offers unprecedented stability. Tango is available with a single or double crown, a matt black or chrome pole and a matt black or silver grey base.

Die Krone des Tango besteht aus hochglanzpoliertem Aluminium. Der schlanke Fuß aus Gusseisen bietet unübertroffene Stabilität. Tango ist mit Einzel- oder Doppelkrone lieferbar. Der Steher ist in den Ausführungen Mattschwarz oder Chrom erhältlich und der Fuß in Schwarz oder Silbergrau.

## MATERIAL AND FINISH

Polished aluminium crown

Steel upright in chrome or powder coating

Cast iron base

## COLOURS UPRIGHT



CHROME



TRAFFIC BLACK

## COLOURS BASE



ALUMINIUM



TRAFFIC BLACK

## DIMENSIONS (CM)

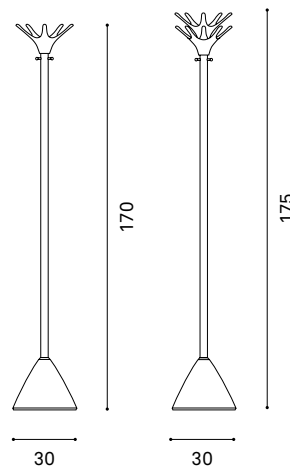



# Snow

DESIGN ROBERT BRONWASSER

Snow is a coat stand with a top in the shape of an ice crystal. The clean cut, minimalist coat stand is made of steel and aluminium and can hold up to 16 coats.

Snow ist ein Garderobenständer mit einer Krone in der Form eines Eiskristalls. Der ausgesprochene, minimalistische Garderobenständer ist gefertigt aus Stahl und Aluminium und bietet Platz für bis zu 16 Mäntel.

## MATERIAL AND FINISH

Powder coated steel base  
Powder coated aluminium upright  
Powder coated steel top

## COLOUR



TRAFFIC WHITE

## DIMENSIONS (CM)





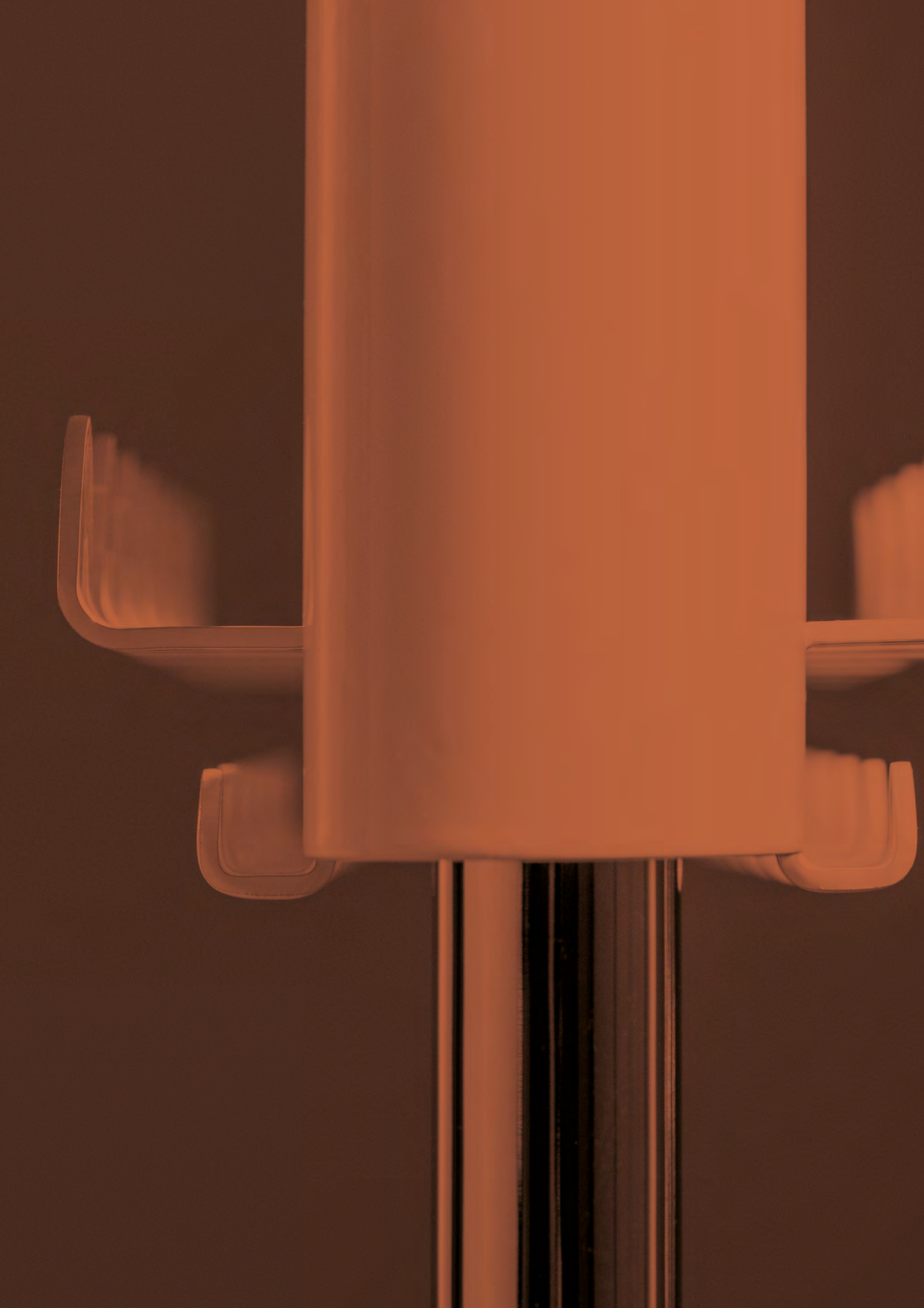

# Coat racks





# Round20 Single

DESIGN ROBERT BRONWASSER

The wood version of the Round20 series is a beautiful lined coat rack with room for hooks and hangers. It can also be combined with all the other accessories available in the Round20 series. The wooden frame comes in natural oak, black or white. The frames are available in several widths and can also be joined together.

Die Holz Version der Round20 Serie ist eine wunderschön geformte Garderobe für Kleiderbügel und Kleiderhaken. Sie kann auch mit allen anderen Zubehören der Round20 Serie kombiniert werden. Die Rahmen gibt es in Eiche Natur, Schwarz und Weiß. Round20 Single ist in verschiedenen Breiten lieferbar und kann verkettet werden.



## MATERIAL AND FINISH

Wooden uprights

Casters with brakes

Anodized aluminium bars

## COLOURS



NATURAL OAK

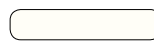

WHITE



BLACK

## DIMENSIONS (CM)

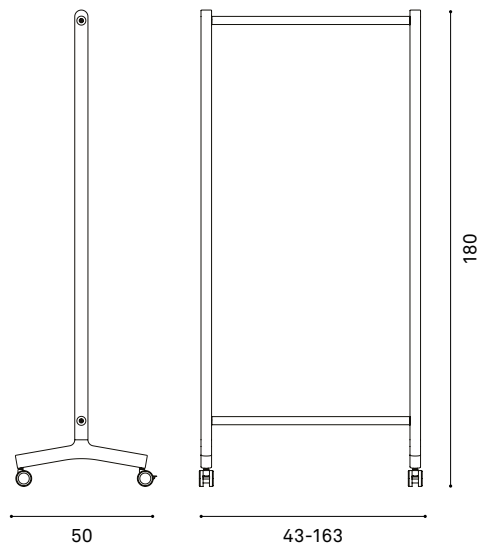

## ADDITIONAL

Matching coat hanger: Pole hanger

Accessories: brochure holders, acoustic panels and whiteboards



# Round20 Double

DESIGN ROBERT BRONWASSER

The Round20 Double element offers double hanging capacity. The Round20 Double is available in various widths and can also be joined together. The wooden uprights are available in natural oak, black and white, and can be provided with hooks or coat hangers.

Das Round20 Double Element bietet doppelte Aufhängekapazität. Round20 Double ist in verschiedenen Breiten lieferbar und kann verkettet werden. Die Elemente sind in Eiche Natur, in Schwarz und Weiß lieferbar und können mit Garderobenhaken oder Kleiderbügel bestückt werden.



## MATERIAL AND FINISH

Wooden uprights  
Casters with brakes  
Anodized aluminium bars

## COLOURS

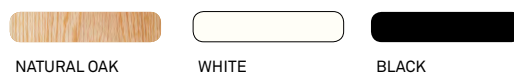

## DIMENSIONS (CM)

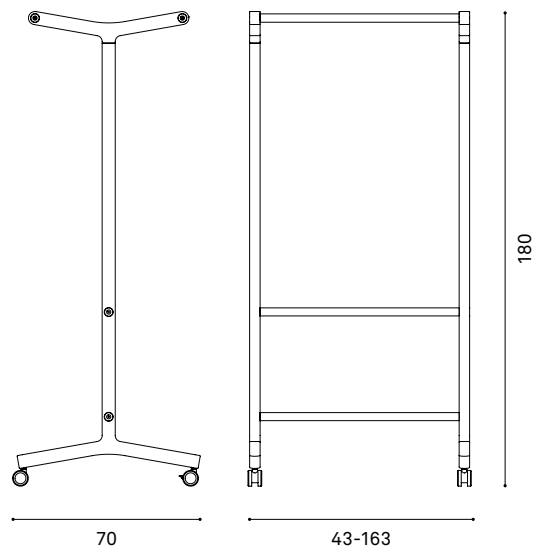

## ADDITIONAL

Matching coat hanger: Pole hangers





# Round20 Alu

DESIGN ROBERT BRONWASSER

The Round20 Alu has an aluminium upright and a steady steel base with casters. The front casters are also equipped with brakes. The uprights are available in white or anodized aluminium. The horizontal bars offer plenty of space for coat hooks and hangers. Round20 Alu elements are available in various widths and can be perfectly combined with all the functionality of the Round20 series.

Round20 Alu hat Aluminiumständer und ein Untergestell aus Stahl mit Rollen. Die vorderen Rollen sind bremsbar. Die Ständer sind in weißem Lack oder in anodisiertem Aluminium lieferbar. Die Aluminiumrohre bieten viel Platz für Garderobenhaken und Kleiderbügel. Round20 Alu Elemente sind lieferbar in mehreren Breiten und ausgezeichnet kombinierbar mit allen Funktionen der Round20 Serie.

## MATERIAL AND FINISH

Anodized aluminium bars

Anodized or powder coated aluminium uprights

Steel base with casters and brakes

## COLOURS



TRAFFIC WHITE



ANODISED ALU

## DIMENSIONS (CM)

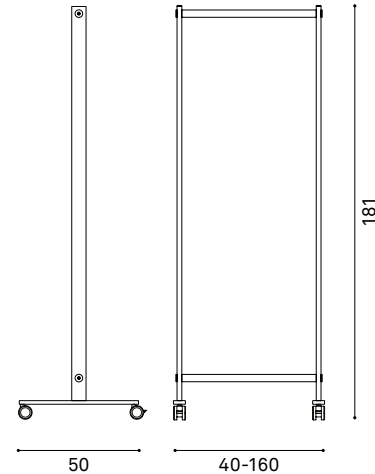

## ADDITIONAL

Matching coat hanger: Pole hangers

Accessories: brochure holders, acoustic panels and whiteboards

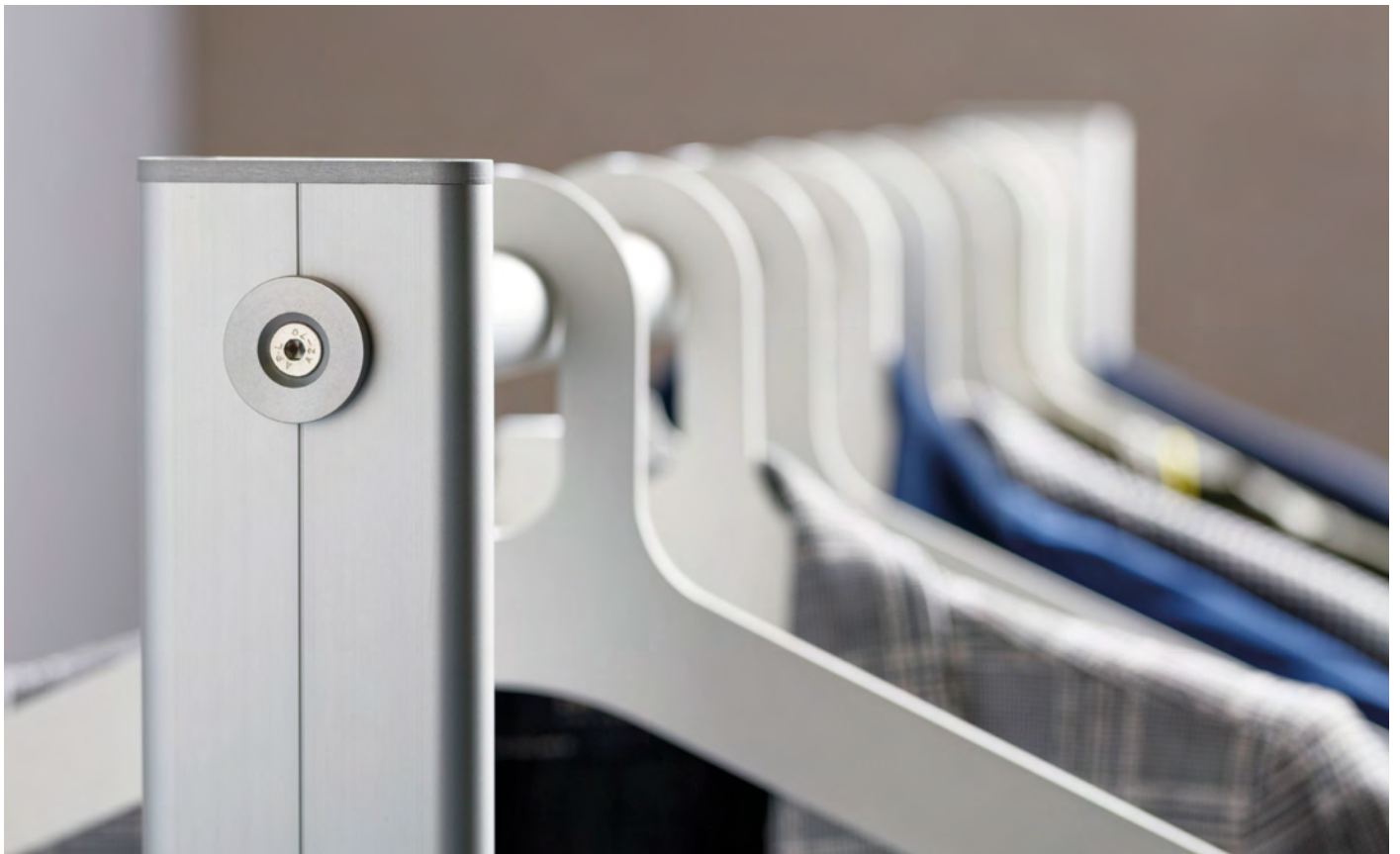





# Round20 Delta

DESIGN ROBERT BRONWASSER

The Delta element from the Round20 series has its own form, but provides the same functionality as the other Round20 products. The Delta uprights are made of MDF and only available in white. The element can be used with wardrobe hooks as well as with coat hangers.

Das Delta-Element aus der Round20-Serie hat eine ganz eigene Form, bietet aber die gleich hohe Funktionalität wie die anderen Round20-Ständer. Der Delta-Ständer aus MDF wird serienmäßig in Weiß geliefert. Das Element kann mit Garderobenhaken oder Kleiderbügel benutzt werden.



## MATERIAL AND FINISH

Anodized aluminium bars  
Lacquered MDF uprights  
Casters with brakes

## COLOUR

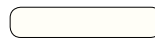

TRAFFIC WHITE

## DIMENSIONS (CM)

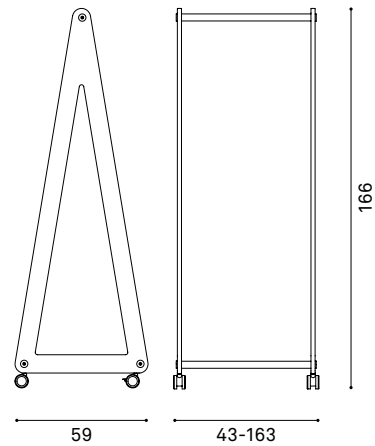

## ADDITIONAL

Matching coat hanger: Pole hangers

Accessories: brochure holders and whiteboards

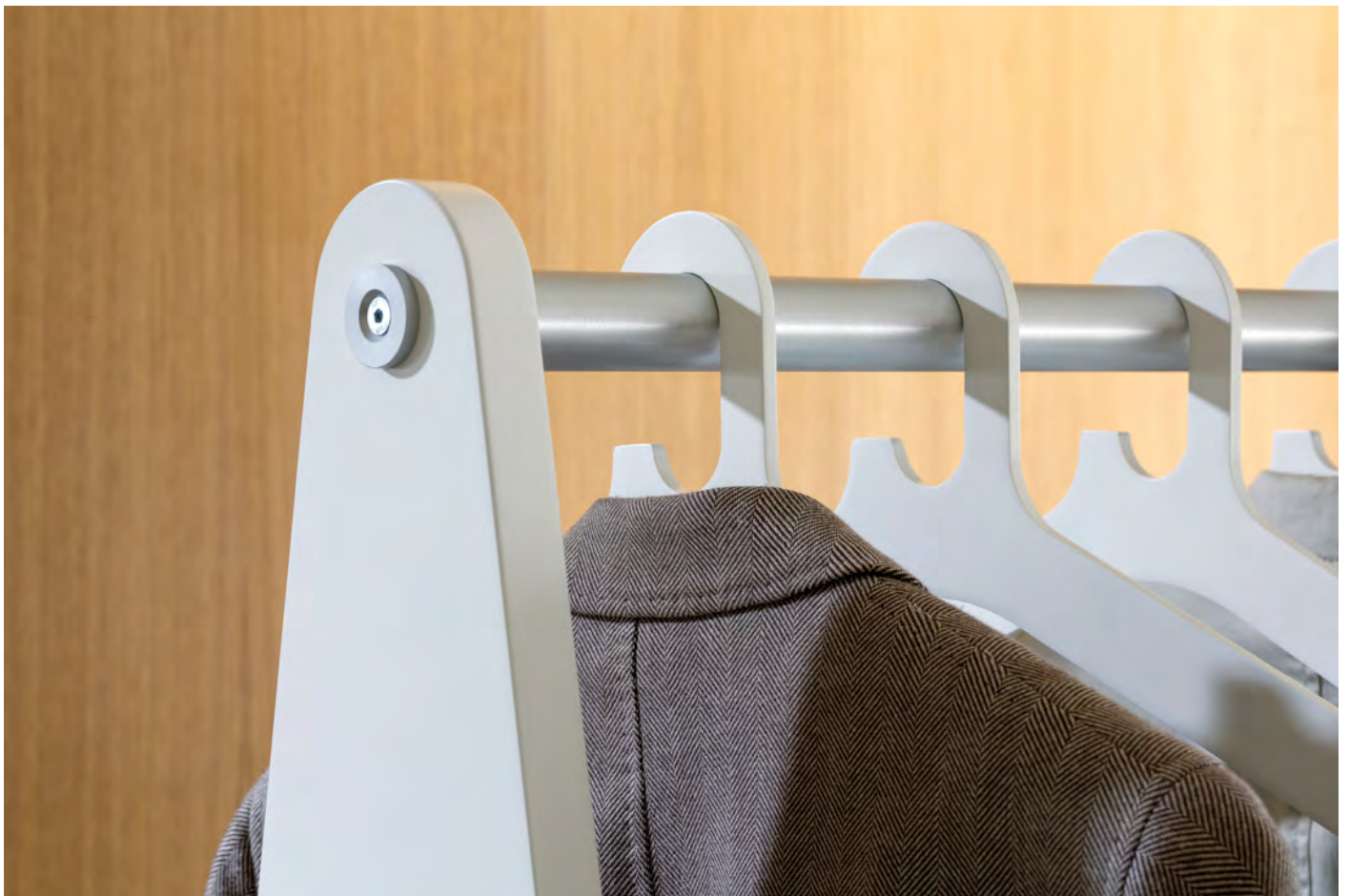

# Standtogether

DESIGN ONNO DE KNEGT

Hidden casters make the Standtogether wardrobe easy to move around. The horizontal bar comes with twelve grooves, ensuring that the coats hang neatly in a row. The bar is also available without grooves, for example for use with closed hangers or more than twelve hangers.

Unsichtbare Schwenkrollen machen das Umstellen der Standtogether Projektgarderobe einfach. Die Garderobenstange ist mit zwölf Rillen versehen. Die Jacken hängen so ordentlich in einer Reihe. Die Stange ist auch ohne Rillen lieferbar, z.B. für die Verwendung mit geschlossenen Bügeln oder für mehr als zwölf Bügeln.



## MATERIAL AND FINISH

Polished aluminium bar  
Powder coated aluminium uprights  
Powder coated steel base

## COLOUR



ALUMINIUM

## DIMENSIONS (CM)

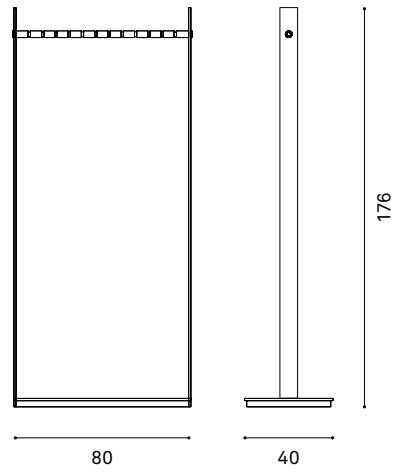

## ADDITIONAL

Matching coat hanger: Chrome hanger

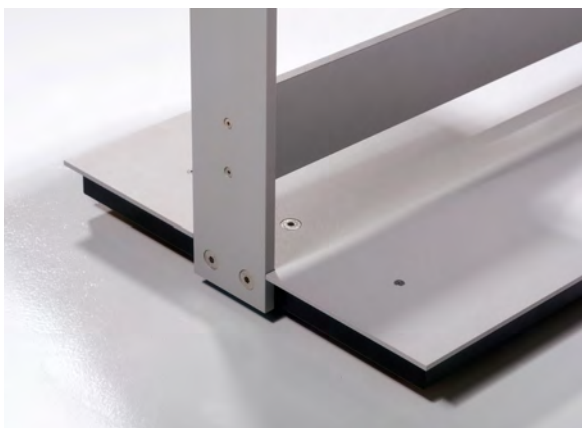

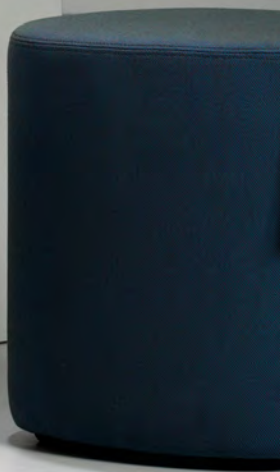

# Lean On

DESIGN PETER VAN DE WATER

Because of its curved shape, this graceful coat stand rests steadily against the wall. The polished stainless steel of the hanging bar and the high-gloss white frame provide an unusual but pleasing contrast.

Durch seine gebogene Form lehnt dieser charmante Garderobenständer stabil gegen die Wand. Das polierte Edelstahl der Garderobenstange und der hochglänzende, weiße Rahmen bilden einen besonderen Kontrast.

## MATERIAL AND FINISH

Stainless steel  
Powder coated steel

## COLOUR



TRAFFIC WHITE

## DIMENSIONS (CM)

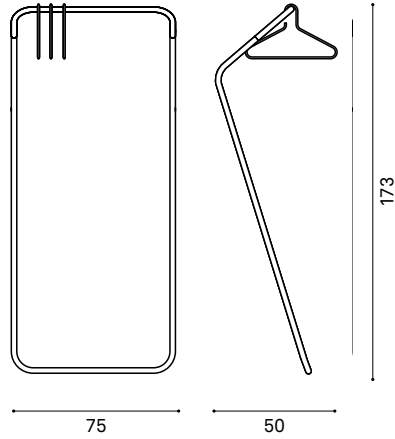

## ADDITIONAL

Matching coat hanger: Lean On hanger





# Focus

DESIGN GERALD BRANDSTÄTTER

The rounded frame and base of Focus are made of steel. Timeless, high-quality and modern, it is available in high-gloss white or silver grey. As the horizontal polished aluminium bar is grooved, the coats hang at regularly spaced intervals.

Der abgerundeten Rahmen und der Fuß des Fokus sind aus Stahl. Zeitlos, hochwertig und modern. Lieferbar in hochglänzendem Weiß oder Silbergrau. Weil die poliert Aluminium Garderobenstange mit Rillen versehen ist, hängen die Jacken im gleichen Abstand zueinander.

## MATERIAL AND FINISH

Powder coated steel upright and base  
Polished aluminium horizontal bar

## COLOURS



## DIMENSIONS (CM)

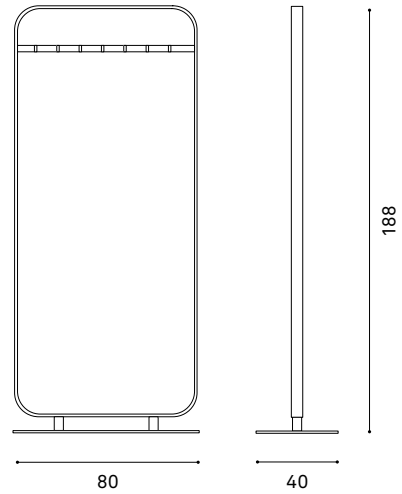

## ADDITIONAL

Matching coat hanger: Chrome hanger





# Flow Large

DESIGN MARLEEN VALSTAR

Flow Large has fourteen sturdy hooks with additional small hooks beneath them. As a result, this coat stand can hold a large number of coats. The steel base ensures optimal stability.

Flow Large hat vierzehn kräftige Haken mit darunter zusätzlichen Aufhängern. Dadurch bietet der Garderobenständer Platz für viele Jacken. Der stählerne Fuß sorgt für optimale Stabilität.



## MATERIAL AND FINISH

Chromed steel uprights

Powder coated steel hooks and base

## COLOUR CROWN



## COLOUR BASE



TRAFFIC WHITE

## DIMENSIONS (CM)

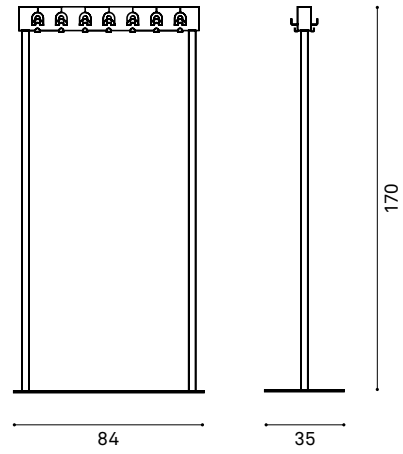



# Forest

DESIGN ROBERT BRONWASSER

Forest, part of Cascando's Nature series, can be provided with hooks, coat hangers or a combination of the two. There is a choice of widths. For extra capacity, the element can be expanded to include multiple uprights.

Forest, Teil der Nature-Serie von Cascando, kann nach Wunsch mit Garderobenhaken, Kleiderbügeln oder einer Kombination aus beiden ausgestattet werden. Sie haben die Wahl zwischen verschiedenen Breiten. Für zusätzliche Kapazitäten kann das Element mit mehreren Ständern erweitert werden.

## MATERIAL AND FINISH

Lacquered MDF uprights  
Anodized horizontal bars

## COLOURS



TRAFFIC WHITE



OLIVE GREEN



WARM GREY

## DIMENSIONS (CM)

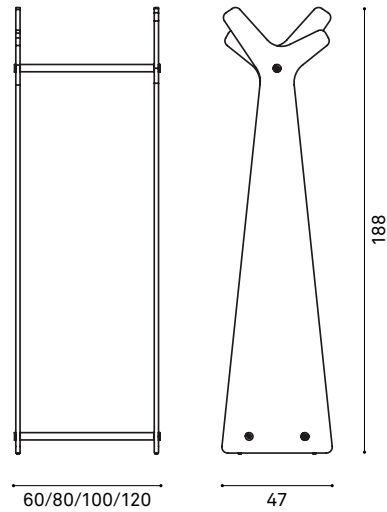

## ADDITIONAL

Matching coat hanger: Pole hanger

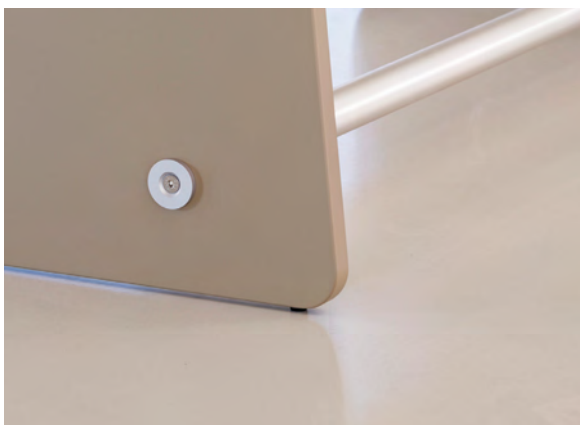



# Pillow Space

DESIGN ROBERT BRONWASSER

Pillow Space wardrobes offer two different ways of storing coats. On the outside, by coat hooks on the panels, or on the inside of the space divider. It is also possible to combine the internal and external storage. Optionally the internal storage space can be closed by a door.

Pillow Space Garderobe Elemente bieten zwei verschiedene Möglichkeiten Mäntel auf zu bewahren. An der Aussenseite, mittels Mantelhaken auf den Paneelen, oder innerhalb des Raumteilers. Beide Optionen sind auch zu kombinieren. Der Stauraum kann auf Wunsch mit einer Türe versehen werden.

## MATERIAL AND FINISH

Fabric front and rear (as per choice)

Powder coated steel

Casters with brake

## ACOUSTIC PROPERTIES

Standard or premium

## DIMENSIONS (CM)

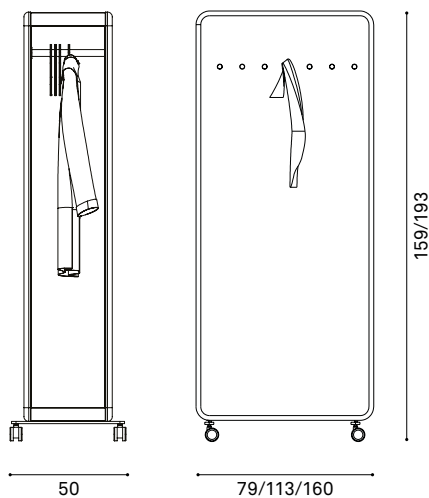

## ADDITIONAL

Matching coat hanger: Pole hanger

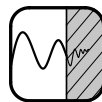

Absorption

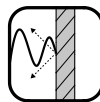

Attenuation

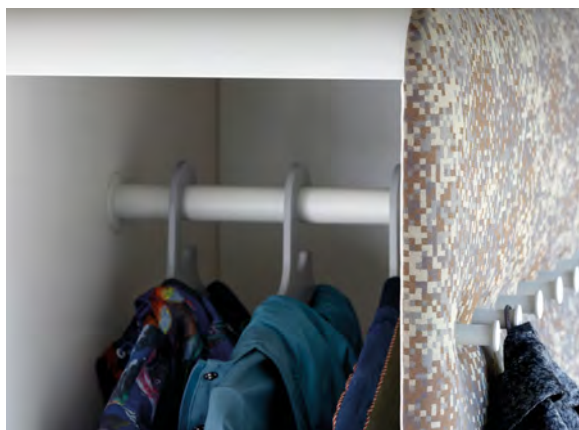
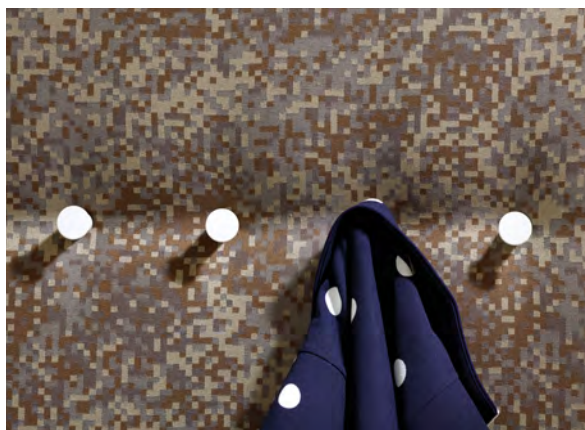



# Coat hooks



P. 158-177



# Flow

DESIGN MARLEEN VALSTAR

The Flow coat hook is available with one, three or seven hooks.  
The elements can be used individually as well as in series. Flow is  
available in gloss white and aluminium grey.

Flow Wandgarderobe gibt es mit einem, drei oder sieben Haken.  
Die Elemente können sowohl einzeln als auch in Serie  
verwendet werden. Flow ist in hochglänzendem Weiß  
und Silbergrau lieferbar.



## MATERIAL AND FINISH

Powder coated steel

## COLOUR



TRAFFIC WHITE



ALUMINIUM

## DIMENSIONS (CM)

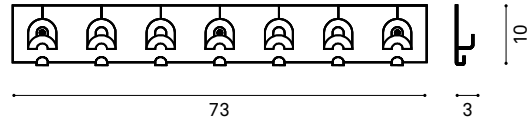
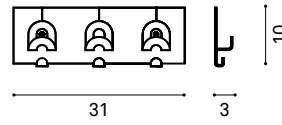
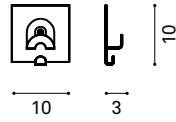

# Round20 Wall

DESIGN ROBERT BRONWASSER

Round20 offers a complete range of wall panels with cloth hangers and coat hooks. This allows you to design a personal wardrobe solution. The anodized aluminium surface (Alucobond) gives the series a modern, architectural signature.

Round20 bietet eine komplette Palette von Wandpaneelen mit Kleiderbügeln und Kleiderhaken. Dies ermöglicht Ihnen eine persönliche Garderobelösung zu entwerfen. Die anodisierte Aluminiumoberfläche (Alucobond) verschafft dieser Serie eine moderne, architektonische Signatur.



## MATERIAL AND FINISH

Alucubond

## ADDITIONAL

Matching coat hanger: Pole hanger

## DIMENSIONS (CM)

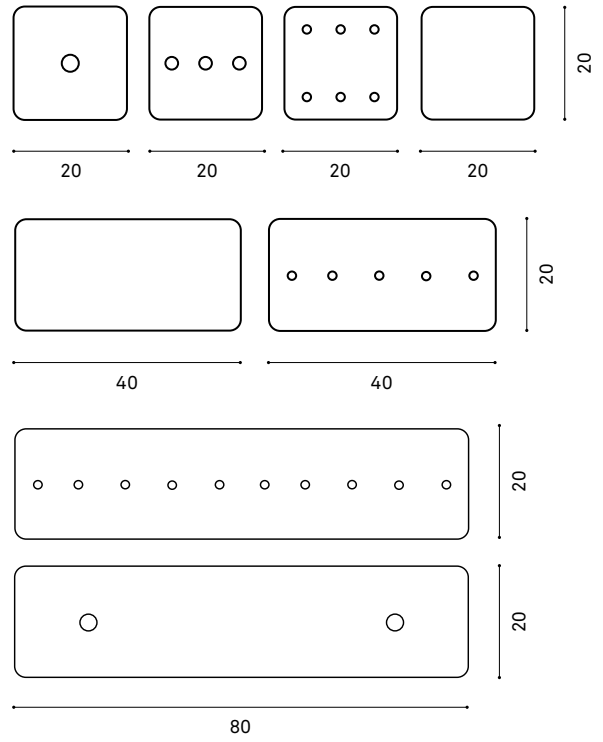



# Hangon 1-2-3-Double

DESIGN ONNO DE KNEGT & PETER VAN DE WATER

The Hangon wardrobe series comes in several different versions – the Hangon 1, 2 or 3. Their hooks are equipped with either one, two or three grooves, depending on the amount of coat hangers you would like to accommodate. Hangon Double is the wide version, offering double capacity. The back panels are available in aluminium and oak, the hook in polished aluminium, black and white.

Hangon Wandgarderoben gibt es in verschiedenen Ausführungen: Hangon 1, 2 oder 3, ausgestattet mit einer, zwei oder drei Rillen, je nach der Menge der Kleiderbügel die Sie verwenden möchten. Hangon Double ist die breite Version und bietet doppelte Kapazität. Die Wandpaneele gibt es in Aluminium und Eiche, die Haken in poliertem Aluminium, Weiß und Schwarz.



## MATERIAL AND FINISH

Back panel in aluminium or oak  
Hooks in polished aluminium, black or white

## COLOURS BACKPANEL



## COLOURS HOOK

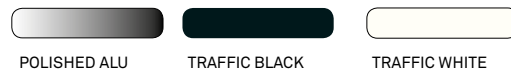

## HANGON DIMENSIONS (CM)

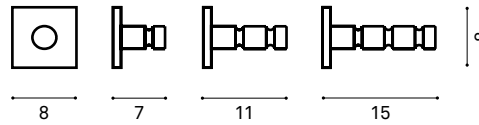

## HANGON DOUBLE DIMENSIONS (CM)

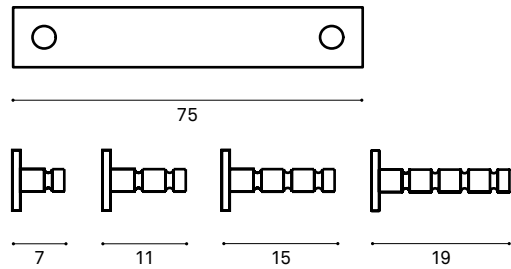

## ADDITIONAL

Matching coat hanger: Chrome hanger





# Hangon 7-12

DESIGN ONNO DE KNEGT & PETER VAN DE WATER

Hangon 7 has a transparent and clear shape. The polished aluminium wardrobe bar comes with grooves but, if desired, also without. The wardrobe is available in two widths and is suitable for seven to twelve hangers. Hangon 12 also has an extended rear wall offering additional coat hooks. The hat shelf is made of hardened glass.

Hangon 7 hat eine transparente und klare Form. Die Garderobenstange aus poliertem Aluminium ist mit Rillen versehen, aber auch ohne erhältlich. Die Wandgarderobe ist in zwei Breiten lieferbar und für sieben bis zwölf Kleiderbügel geeignet. Hangon 12 hat eine verlängerte Rückwand mit zusätzlichen Garderobenhaken. Die Hutablage ist aus gehärtetem Glas.



## MATERIAL AND FINISH

Polished aluminium horizontal bar  
Hardened glass plate  
Powder coated aluminium panels

## COLOUR



ALUMINIUM

## DIMENSIONS (CM)

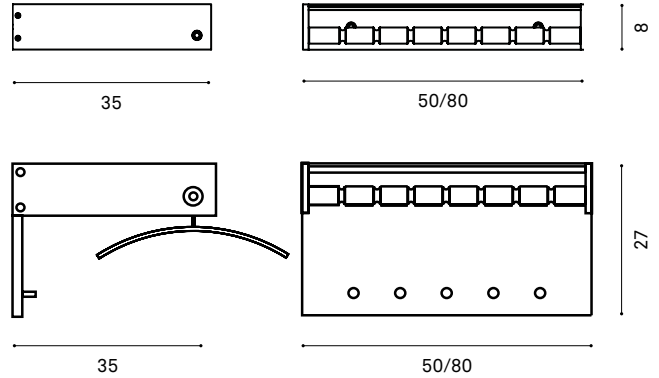

## ADDITIONAL

Matching coat hanger: Chrome hanger





# Stick

DESIGN ROBERT BRONWASSER

Stick exudes pure simplicity. In combination with the matching Pole coat hangers, it creates a strong image, especially when multiple Sticks meet on the wall. Stick is made of coated aluminium and is suitable for either one or two hangers.

Die Wandgarderobe Stick strahlt reine Schlichtheit aus. In Kombination mit dem dazu passenden Kleiderbügel Pole entsteht ein starkes Bild, vor allem wenn mehrere „Sticks“ an der Wand zusammentreffen. Stick ist gefertigt aus pulverbeschichtetem Aluminium und eignet sich für einen oder zwei Bügel.

## MATERIAL AND FINISH

Powder coated aluminium

## COLOUR



GREY WHITE



OLIVE GREEN



WARM GREY



LIGHT GREY



BASALT BLACK

## DIMENSIONS (CM)



12



3



1.5

## ADDITIONAL

Matching coat hanger: Pole hanger



# Clickon

DESIGN ONNO DE KNEGT

Clickon is a magnetic wall hook for use on steel walls or steel cabinets. The wardrobe comes in either a stylish combination of polished and anodized aluminium, or in a powerful powder coating. Clickon is equipped with either one, two or three grooves for hangers.

Clickon ist eine magnetische Wandgarderobe für den Einsatz auf Stahlwänden oder Stahlschränken. Die Garderobe wird entweder in einer stilvolle Kombination von poliertem und eloxiertem Aluminium, oder in einer leistungsstarken Pulverbeschichtung geliefert. Clickon ist mit einer, zwei oder drei Rillen für Bügel ausgestattet.

## MATERIAL AND FINISH

Powder coated or anodized back panel

Powder coated or polished aluminium bars

## COLOURS BACKPANEL



TRAFFIC BLACK



ALUMINIUM

## COLOURS HOOK



POLISHED ALU



TRAFFIC BLACK

## DIMENSIONS (CM)

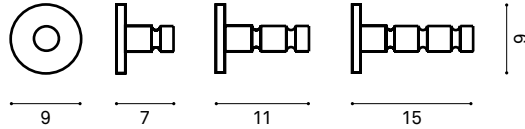

## ADDITIONAL

Matching coat hanger: Chrome hanger



# Bend

DESIGN PETER VAN DE WATER

The Bend coat hook is part of the well-known Bend coat stand series. Coats can be hung on the carefully rounded ends of the strip or on the polished aluminium peg.

Der Bend Kleiderhaken ist Teil der allseits bekannten Bend Garderobenständer Serie. Mäntel kann man einfach auf die sorgfältig abgerundeten Enden des Hakens oder auf den Knopf aus poliertem Aluminium aufhängen

## MATERIAL AND FINISH

Powder coated steel

Polished aluminium pegs

## COLOURS



SIGNAL YELLOW



BASALT GREY

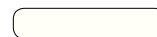

TRAFFIC WHITE

## DIMENSIONS (CM)

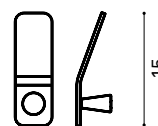

5 4 15



# Hemisphere

DESIGN PHIL PROCTER

The ash wood Hemisphere coat hooks are available in three different sizes. They can store coats, bags and accessories. A small angle on the rear of each hemisphere encourages playfulness when arranging the hangers as the tilt and orientation of each hanger can be decided by the user.

Hemisphere Wandgarderoben aus Esche sind in drei verschiedenen Größen erhältlich. Sie können verwendet werden zum Aufhängen von Mänteln, Taschen und Accessoires. Die nicht mittigen Befestigungspunkte ermöglichen eine spielerische Komposition, da Neigung und Ausrichtung jeder Garderobe individuell bestimmt werden kann.



## MATERIAL AND FINISH

Ash wood

## COLOURS



## DIMENSIONS (CM)

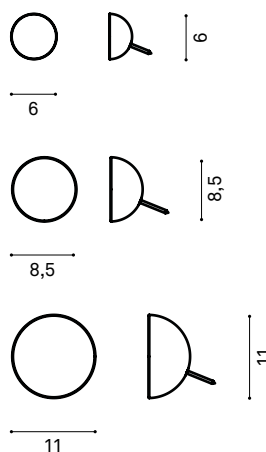

# Tango

DESIGN MINKE VAN VOORTHUIZEN

The Tango wall wardrobe is cast from high gloss polished aluminium. The mounting on the wall is done using a sophisticated invisible construction.

Die Wandgarderobe Tango ist aus Hochglanz poliertem Aluminium gegossen. Die Befestigung an der Wand geschieht mit einer durchdachten unsichtbaren Konstruktion.

## MATERIAL AND FINISH

Polished aluminium

## DIMENSIONS (CM)

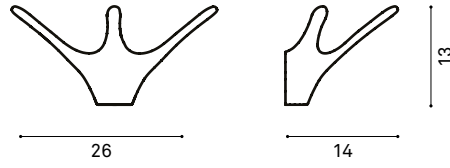

# Flake

DESIGN ROBERT BRONWASSER

Like the Snow coat stand, Flake has the striking shape of an ice crystal and provides space for at least four coats. The wardrobe is manufactured from steel and then coated in a textured matt white powder coating.

Wie der Snow Garderobenständer, hat Flake die markante Form eines Eiskristalls. Flake bietet Platz für mindestens vier Mäntel. Die Garderobe ist aus Stahl gefertigt und mit weißem Texturlack beschichtet.

## MATERIAL AND FINISH

Powder coated steel

## COLOURS



TRAFFIC WHITE

## DIMENSIONS (CM)

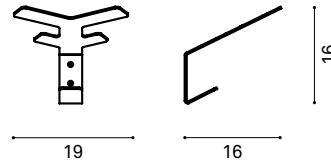

# Bamboo Wall

DESIGN PETER VAN DE WATER

The white polyamide hooks of Bamboo are easily adjustable: slide the hook up, adjust the rubber O-ring, and then just click the hook back into place. Bamboo is available in two lengths. The short version has three hooks, the long version has five.

Die Haken aus mattweißem Kunststoff sind leicht verstellbar: schieben Sie die Haken nach oben, verstellen Sie den O-Ring aus Gummi und klicken Sie den Haken wieder in seine Position zurück. Bamboo ist in zwei Längen lieferbar. Die kurze Ausführung hat drei Haken, die lange Ausführung fünf.



## MATERIAL AND FINISH

Bamboo upright  
Polyamide hooks

## COLOUR HOOKS



TRAFFIC WHITE

## DIMENSIONS (CM)

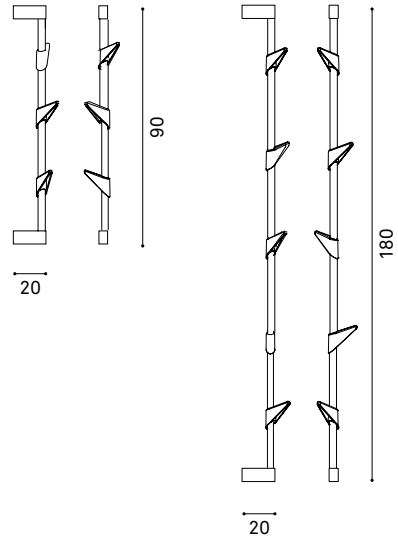



# Velvet

DESIGN MARLEEN VALSTAR

The Velvet wardrobe is made of anodized aluminium with pegs in white, black or orange polyamide. Small additional hooks provide additional capacity. It is available in two versions, with one single arm or a combination of three arms.

Die Wandgarderobe Velvet besteht aus geschliffenem anodisiertem Aluminium mit Knöpfen aus weißem, schwarzem oder orangem Polyamide. Kleine zusätzliche Haken sorgen für zusätzliche Kapazität. Lieferbar in zwei Ausführungen; mit einem Arm oder mit drei Armen.

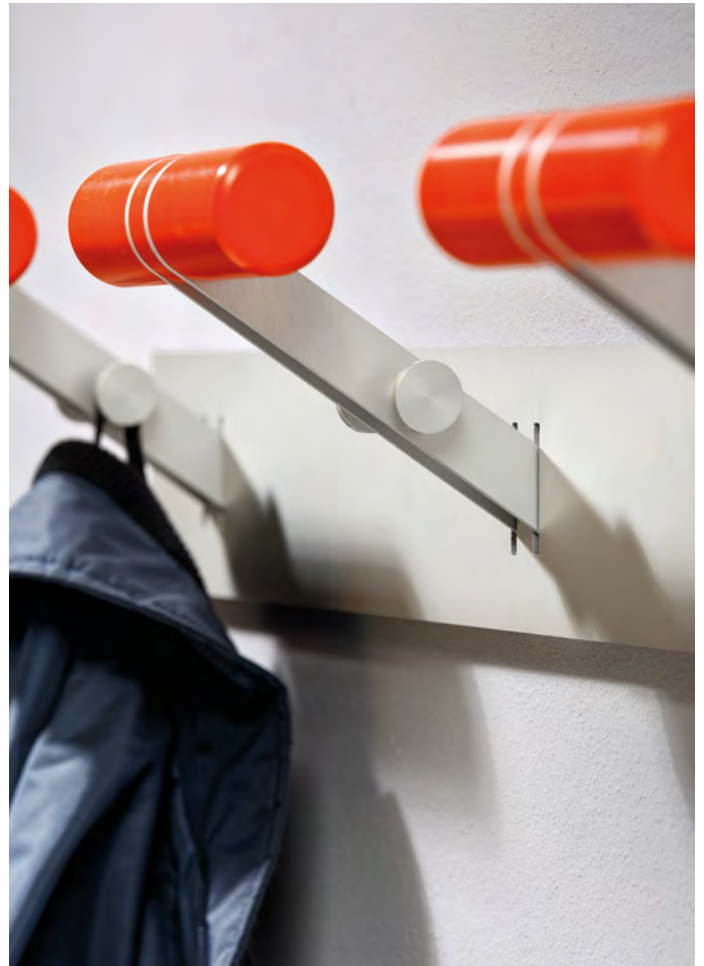

## MATERIAL AND FINISH

Anodised aluminium frame  
Polyamide pegs

## COLOURS



ORANGE

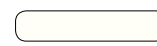

WHITE



BLACK

## DIMENSIONS (CM)



12

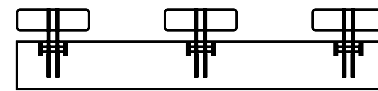

60



13

14

# Kangaroo

DESIGN ROBERT BRONWASSER

Kangaroo is made of solid cast aluminium and is available in four modern colours. The polished aluminium version creates an exclusive, high-quality appearance in each room.

Kangaroo wird aus massivem Aluminium gegossen und ist in vier modernen Farben lieferbar. Die Ausführung in glänzend poliertem Aluminium schafft in jedem Raum eine exklusive, hochwertige Ausstrahlung.

## MATERIAL AND FINISH

Polished aluminium

Powder coated aluminium

## COLOURS



ORANGE



TRAFFIC WHITE



TRAFFIC BLACK



LIME GREEN



POLISHED ALU

## DIMENSIONS (CM)

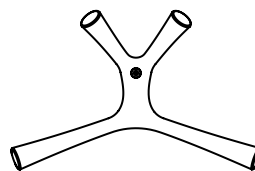

44

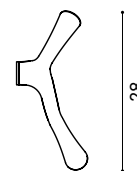

28

12





# Branch

DESIGN ROBERT BRONWASSER

Branch is a wardrobe that is part of the Nature series. Each wardrobe element is made of lacquered MDF and has five coat hooks. You can create your own branch by combining different shapes and colours.

Branch ist die Wandgarderobe aus der Nature-Serie. Branch besteht aus lackiertem MDF und hat fünf Mantelhaken. Kombinieren Sie verschiedene Zweige und Farben und Sie entwerfen Ihren eigenen Zweig.

## MATERIAL AND FINISH

Lacquered MDF

Lacquered coat hooks

## COLOURS

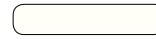

TRAFFIC WHITE



OLIVE GREEN



WARM GREY

## DIMENSIONS (CM)

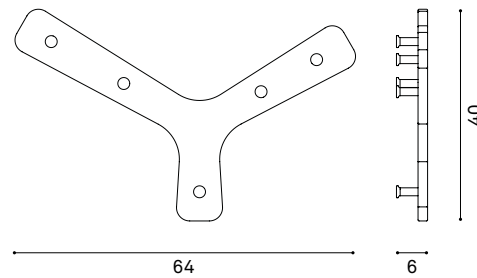

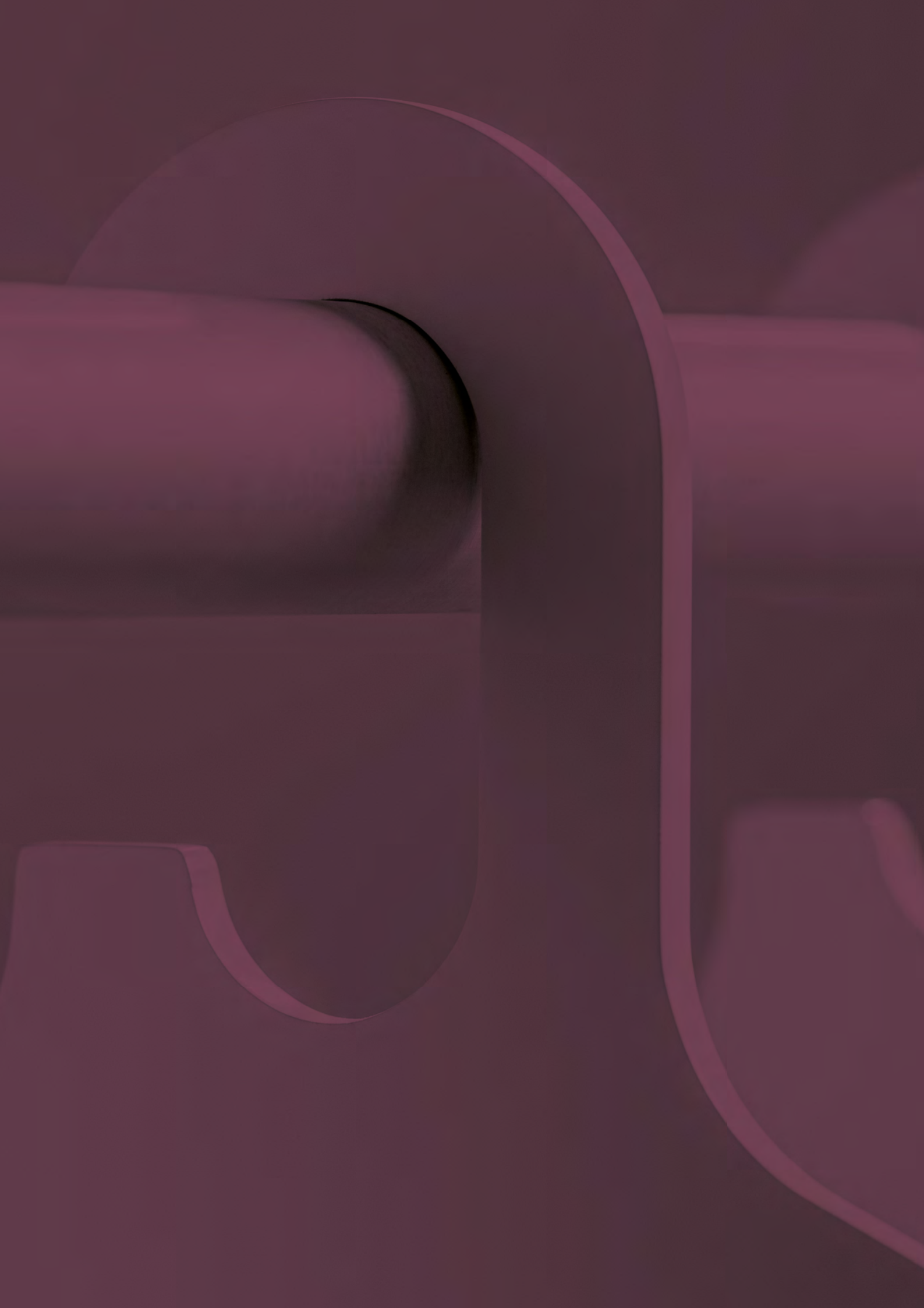

# Coat hangers

P. 180-183



# Pole

DESIGN ROBERT BRONWASSER

Pole coat hanger has a renewed design. The enlarged hook offers improved stability. Pole coat hangers are made of PMMA. The slim shape enables it to fit in with many different wardrobes and it is available in several different colors.

Das neue Design der Pole Kleiderbügel hat einen größeren Haken und bietet eine verbesserte Stabilität. Pole Kleiderbügel sind hergestellt aus PMMA Kunststoff. Das schlichte Design passt zu vielen verschiedenen Garderoben und ist in verschiedenen Farben lieferbar.

## MATERIAL AND FINISH

PMMA

## COLORS



GREY WHITE



TRAFFIC WHITE



TRAFFIC BLACK



LIGHT GREY



BASALT BLACK



OLIVE GREEN



WARM GREY

## DIMENSIONS (CM)

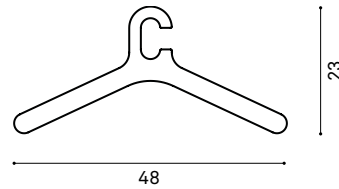

## ADDITIONAL

Maximum bar  $\varnothing$ : 32 mm

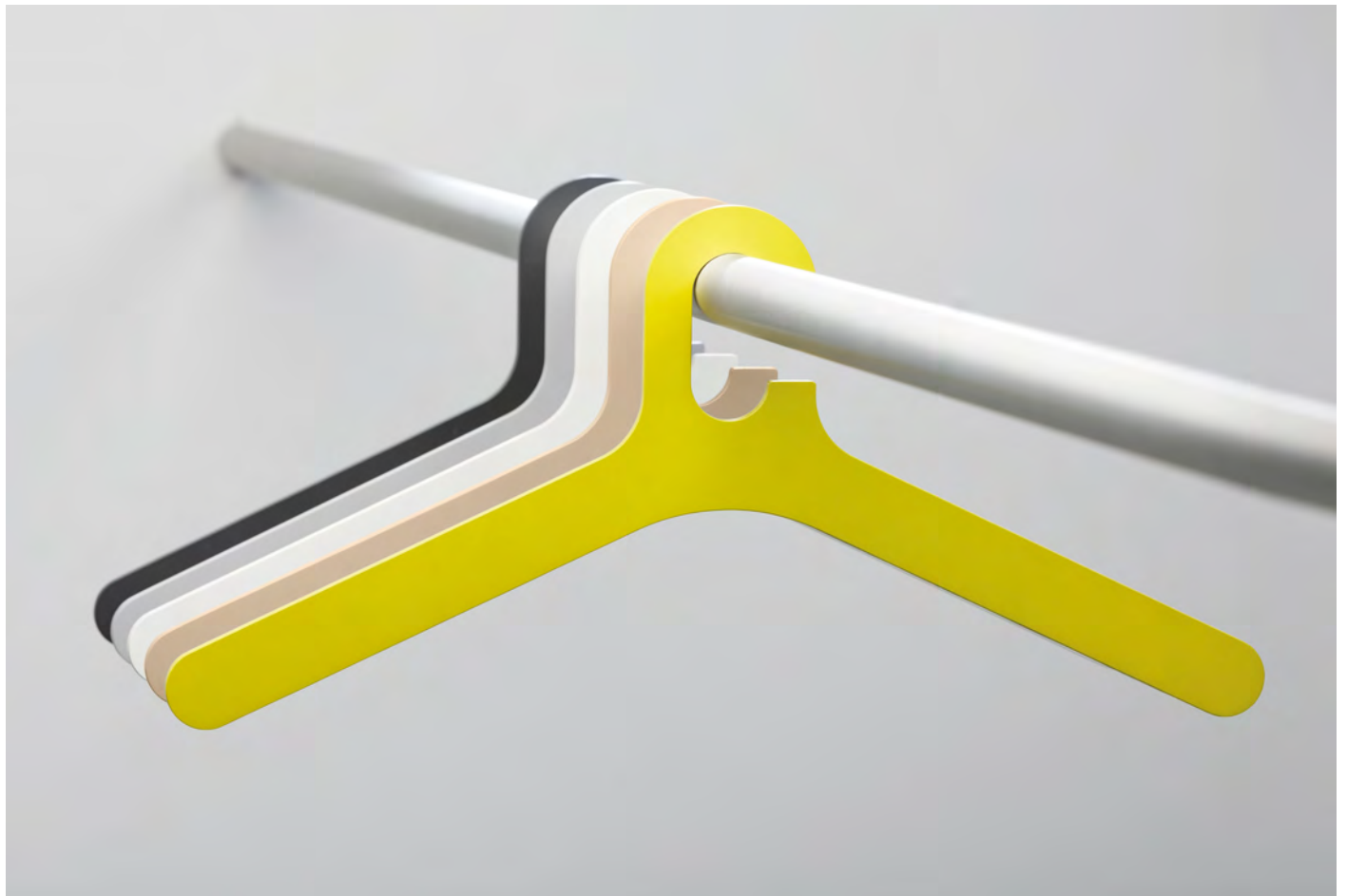



# Lean On

DESIGN PETER VAN DE WATER

The Lean on hangers have a slim, graceful shape. They are made of stainless steel and are available with either an open or closed hook.

Die Lean on Kleiderbügel haben eine schlanke, anmutige Form. Sie werden aus Edelstahl gefertigt. Lieferbar mit offenem oder geschlossenem Haken.

## MATERIAL AND FINISH

Stainless steel

## DIMENSIONS (CM)

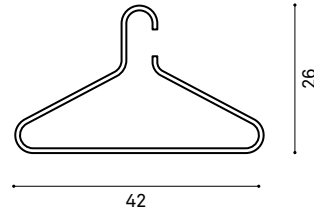

## ADDITIONAL

Maximum bar  $\varnothing$ : 36 mm

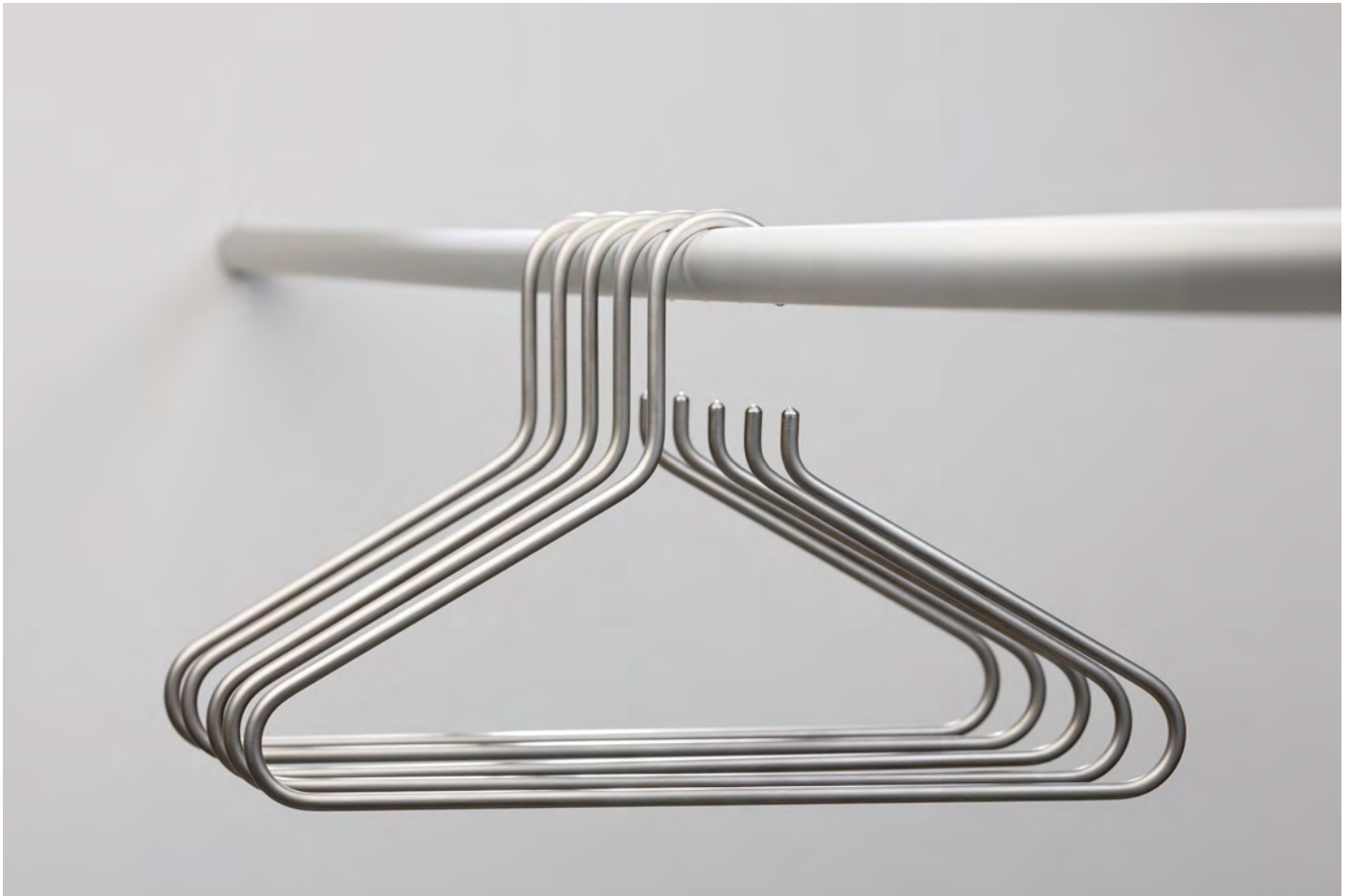

# Chrome

DESIGN CASCANDO STUDIO

Chrome coat hangers are made of steel and have a chrome finish. They are also available with a satin powder coated finish in either black or white. The simple design is highly practical and perfectly matches the Standalone, Standfree, Standtogether and Hangon series. The coat hangers are available with either open or closed hooks.

Die Kleiderbügel Chrome sind aus verchromtem Stahl gefertigt. Auch sind sie pulverbeschichtet in mattem Schwarz oder Weiß erhältlich. Die Gestaltung ist praktisch im Gebrauch und passt perfekt zu Standalone, Standfree, Standtogether und zur Hangon-Serie. Die Kleiderbügel sind mit offenem oder geschlossenem Haken lieferbar.

## MATERIAL AND FINISH

Steel

## COLOURS



CHROME



TRAFFIC WHITE



TRAFFIC BLACK

## DIMENSIONS (CM)

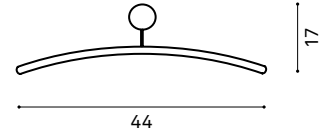
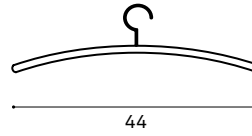

## ADDITIONAL

Maximum bar  $\varnothing$ : 36 mm

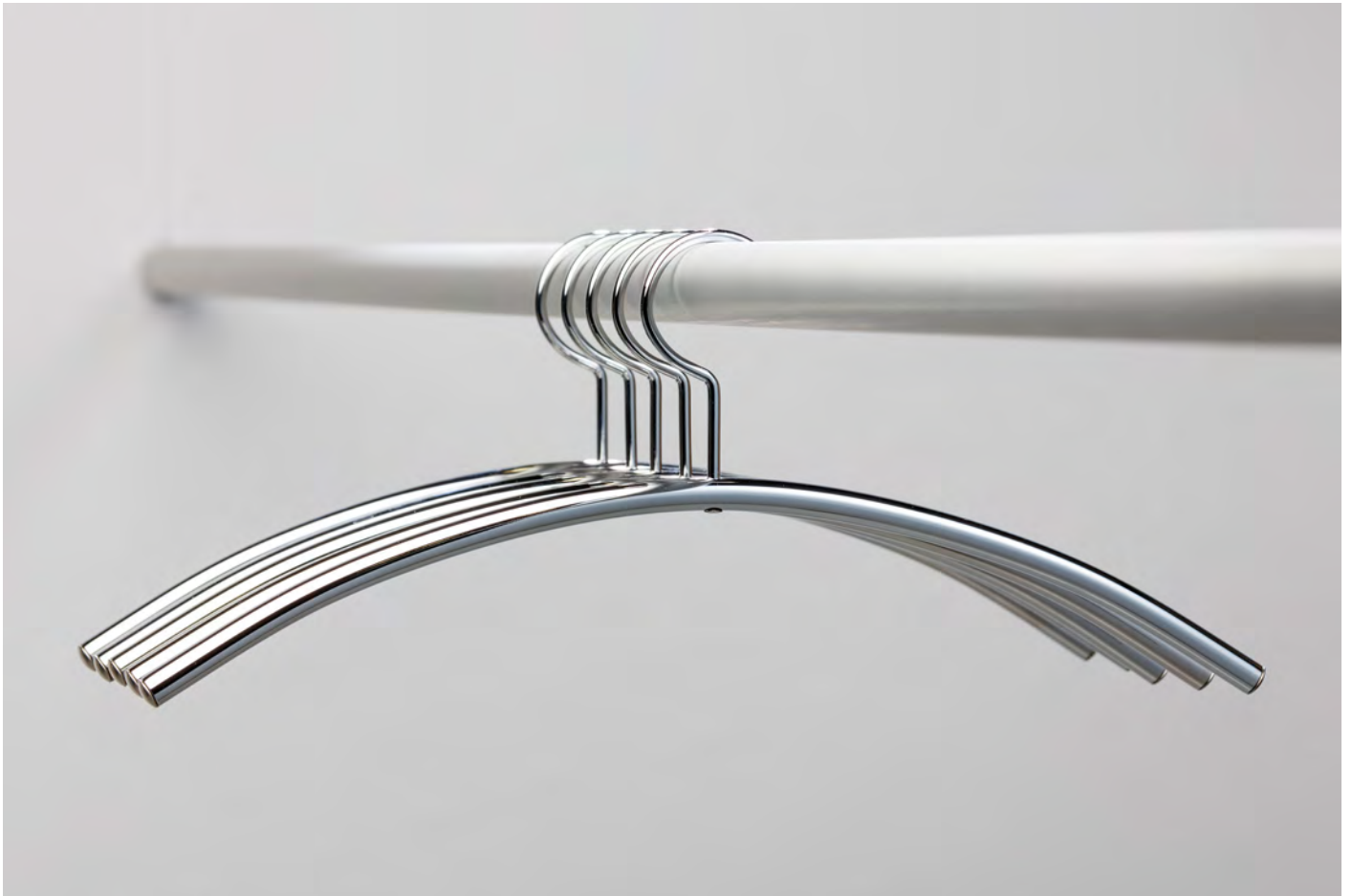



# Tables

P. 186-209

# Blog Work

DESIGN ROBERT BRONWASSER

Blog tables invite cooperation. Blog is a work table for 4 - 6 users and a meeting table for 8 - 10 people. Beautifully cut-out covers (as an option) form an integrated storage space for cables and accessories. Manufactured from Finnish birch plywood and with a top layer in a choice of HPL or Arpa Fenix. The edges can be finished in either oiled plywood or in HPL.

Blog Tische laden ein zur Zusammenarbeit. Blog ist ein Arbeitstisch für 4 bis 6 Benutzer und ein Besprechungstisch für 8 - 10 Personen. Der integrierte Stauraum (Option) für Kabel und Accessoires wird mit formschönen Deckeln verschlossen. Der Blog Tisch ist aus Multiplex von Finnischer Birke gefertigt und nach Wahl mit einer Oberfläche aus HPL oder Arpa Fenix lieferbar. Die Kanten werden entweder in geöltem Multiplex oder in HPL ausgeführt.



## MATERIAL AND FINISH

Finnish birch plywood

Top layer in HPL, Arpa Fenix or Abet Polaris

Table side oiled plywood or HPL

## DIMENSIONS (CM)

140x340

160x360

180x380

200x400

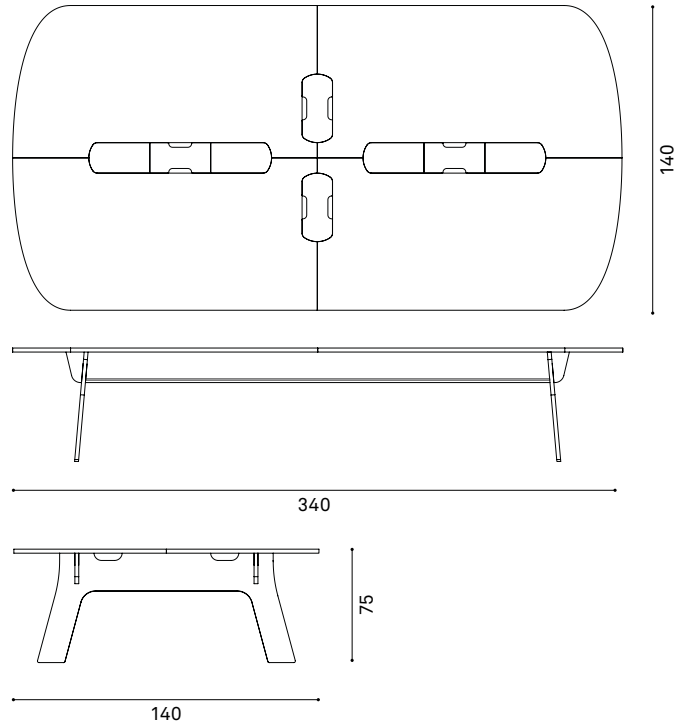



# Blog Talk

DESIGN ROBERT BRONWASSER

Blog Talk is the smallest of the Blog series. Due to its quirky shape, it is particularly suitable for round table meetings. Manufactured from Finnish birch plywood and with a top layer of your choice. The edges can be finished in either oiled plywood or in HPL.

Blog Talk ist der kleinste Tisch aus der Blog Serie. Durch seine eigensinnige Form ist dieser Tisch besonders geeignet für "Runde Tisch Besprechungen". Gefertigt aus Multiplex von Finnischer Birke kann er nach Wahl mit einer Oberfläche aus HPL oder Arpa Fenix geliefert werden. Die Kanten werden entweder in geöltem Multiplex oder in HPL ausgeführt.

## MATERIAL AND FINISH

Finnish birch plywood

Top layer in HPL, Arpa Fenix or Abet Polaris

Table side oiled plywood or HPL

## DIMENSIONS (CM)

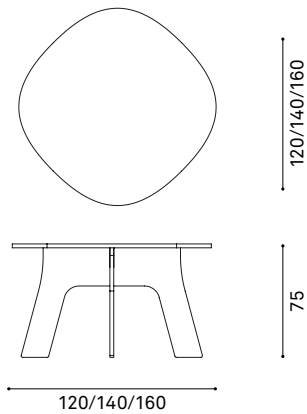





# Blog Meet

DESIGN ROBERT BRONWASSER

Blog tables can be used as a meeting table and also as a work table for one or more persons. The tables are available in various sizes and as an option can be fitted with an integrated storage space for cables and accessories.

Manufactured from Finnish birch plywood and with a top layer in a choice of HPL or Arpa Fenix.

Blog Tische werden als Besprechungs- oder Arbeitstische für eine oder mehrere Personen verwendet. Die Tische sind in verschiedenen Größen lieferbar. Auf Wunsch sind sie mit oder ohne integriertem Stauraum für Kabel und Accessoires erhältlich. Gefertigt aus Multiplex von Finnischer Birke können sie nach Wahl mit einer Oberfläche aus HPL oder Arpa Fenix geliefert werden. Die Kanten werden entweder in geöltem Multiplex oder in HPL ausgeführt.



## MATERIAL AND FINISH

Finish birch plywood

Top layer in HPL, Arpa Fenix or Abet Polaris

Table side oiled plywood or HPL

## DIMENSIONS (CM)

Length table tops 1 piece: 200/220/240

Length table tops 2 pieces: 260 - 400

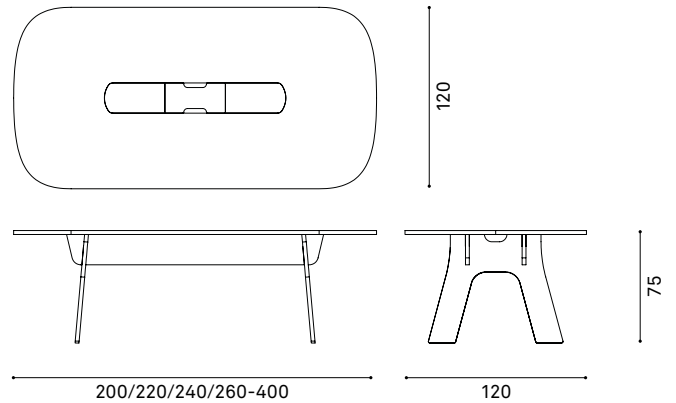



# Team Table

DESIGN CASCANDO STUDIO

Team tables fit in any office, restaurant, lounge or communal zone. The tables can easily be combined with any chair or stool. The high tables are also perfect for working or conversing in an active standing position. The series comes in various dimensions and finishes, specials are available on request. Height adjustable feet are standard. Tables can be assembled on site.

Team Tische bieten jedem Büro, Restaurant, jeder Lounge oder kommunalem Bereich Mehrwert. Das schlichte Design lässt sich einfach kombinieren mit Stühlen oder Hockern. Die hohen Tische eignen sich für Arbeit und Meetings in einer aktiven, stehenden Haltung. Die Serie wird in verschiedenen Abmessungen und Oberflächen geliefert, Sonderausführungen sind möglich. Die höhenverstellbaren Füße sind standard. Die Tische können vor Ort aufgebaut werden.



**MATERIAL AND FINISH**  
Table top and outside panels HPL

**DIMENSIONS (CM)**

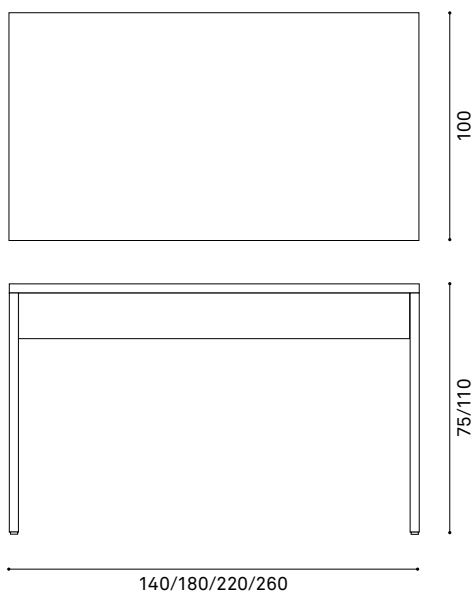

# Basket

DESIGN PETER VAN DE WATER

Basket is a side table made of steel wires which are woven to meet into a pentagonal shape on the floor. The form of the steel table top enables multiple tables to be combined playfully.

Der Beistelltisch Basket ist aus Stahldrähten gefertigt, die auf einfallreiche Art miteinander verwoben sind und auf dem Boden zu einem Fünfeck zusammentreffen. Die Form des Stahlblattes macht es möglich, mehrere Tische spielerisch nebeneinanderaufzustellen.

## MATERIAL AND FINISH

Powder coated steel frame and table top

## COLOURS

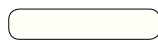

TRAFFIC WHITE



TRAFFIC BLACK

## DIMENSIONS (CM)

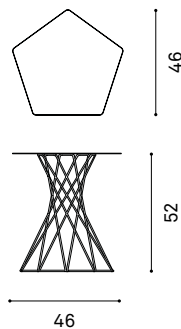

# Careo

DESIGN ONNO DE KNEGT

The characteristic feature of the Careo side table is its unique base of radially polished stainless steel. The tempered glass top with either a transparent or satin finish is available in a round or rectangular shape.

Typisch für die Careo Beistelltische ist das einzigartige Untergestell aus radial geschliffenem Edelstahl. Die gehärtete Glasplatte mit transparenter oder satiniertes Oberfläche ist in runder oder viereckiger Form lieferbar.

## MATERIAL AND FINISH

Stainless steel frame

Satinated or transparent hardened glass table top

## DIMENSIONS (CM)

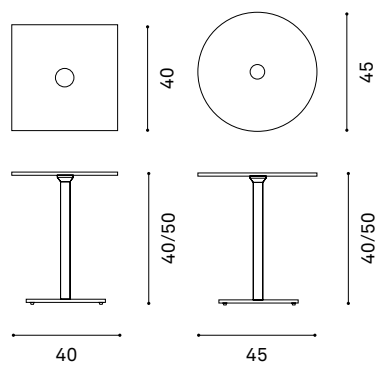

# Flow

DESIGN MARLEEN VALSTAR

The Flow table comes as a dining table, coffee table, lounge table, side table or a bar table. The stable steel base is available in grey or white, the frame in gloss chrome or white.

Der Flow-Tisch wird als Esstisch, Salontisch, Loungetisch, Beistelltisch und Stehtisch geliefert. Der stabile Stahlfuß wird in Silbergrau oder Weiß angeboten, kombiniert mit einem Ständer in Glanzchrom oder in Weiß.

## MATERIAL AND FINISH

Powder coated steel base

Satinated or transparent hardened glass table top

## COLOURS BASE



TRAFFIC WHITE

## COLOURS UPRIGHT



CHROME



TRAFFIC WHITE

## DIMENSIONS (CM)

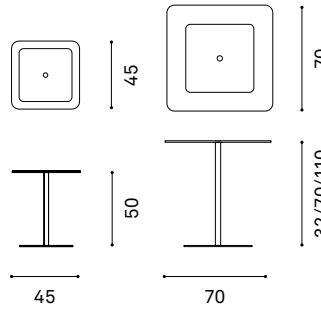

# Velvet

DESIGN MARLEEN VALSTAR

Velvet's simple round frame is made of anodized aluminium. For optimal stability, the foot has been invisibly reinforced with a steel core. The table top is made of tempered glass with either a transparent or satin finish.

Das schlichte runde Tischgestell der Velvet Serie besteht aus anodisiertem Aluminium. Der Fuß ist für optimale Stabilität unsichtbar mit einem Stahlkern verstärkt. Das Blatt aus gehärtetem Glas ist transparent oder satiniert erhältlich.

## MATERIAL AND FINISH

Anodized aluminium frame

Satinated or transparent hardened glass table top

## DIMENSIONS (CM)

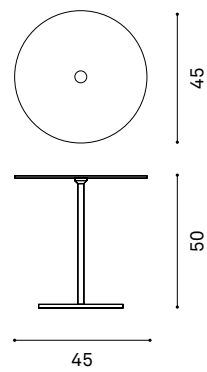



# Team Laptop Table

DESIGN PETER VAN DE WATER

This slender steel laptop table is the perfect partner for Team seating elements. Its freestanding design makes it a practical addition to all types of seating arrangements. The table top can easily be moved into the desired position.

Dieser schmale Laptop Tisch aus Stahl ist der perfekte Partner für die Elemente der Cascando Team Serie. Das freistehende Design ist eine praktische Ergänzung zu allen Arten von Sitzgelegenheiten. Die Tischplatte kann einfach in jede gewünschte Richtung gedreht werden.



## MATERIAL AND FINISH

Powder coated steel frame and table top

## COLOURS

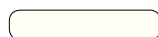

TRAFFIC WHITE

## DIMENSIONS (CM)

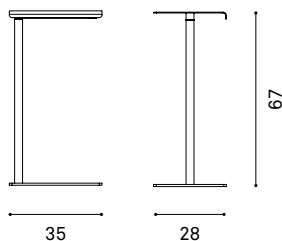

# Cobalt

DESIGN MINKE VAN VOORTHUIZEN

Cobalt tables are characterized by their iconic base which is made of cast iron. They are available in various different heights and diameters meaning that there is always a suitable table for every situation: a side table, salon table, dining table or bar table.

Cobalt Tische werden charakterisiert durch den ikonischen Fuss aus Gusseisen. Sie sind in verschiedenen Höhen und Blattgrößen lieferbar. Dadurch passen sie immer: als Beistelltisch, Salontisch, Esstisch und Stehtisch.

## MATERIAL AND FINISH

Stainless steel upright

Cast iron base

Satinated or transparent hardened glass table top

## COLOURS



ALUMINIUM



TRAFFIC BLACK

## DIMENSIONS (CM)

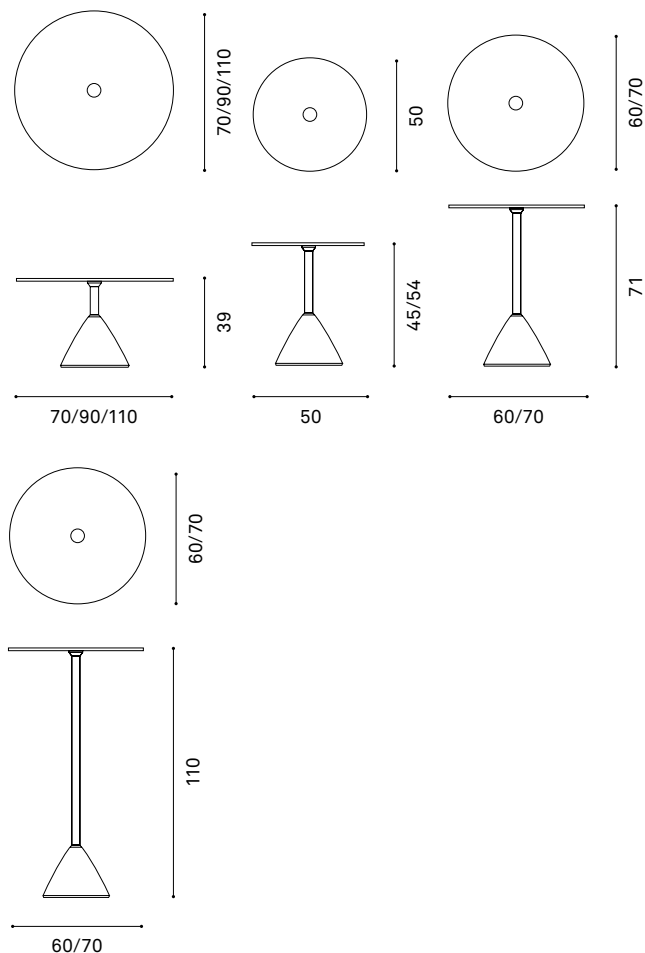

# Stainless

DESIGN CASCANDO STUDIO

The dining tables, salon tables, side tables and bar tables from the Stainless series are modest in terms of form. The frame is made of matt polished steel. The table top consists of hardened glass which is either transparent or satinated. Other table top materials are available upon request.

Die Esstische, Salontische, Beistelltische und Stehtische aus der Stainless - Serie sind schlicht im Design. Das Untergestell ist aus matt geschliffenem Edelstahl. Die Tischplatte besteht aus gehärtetem Glas das transparent oder satiniert lieferbar ist. Andere Materialien sind auf Anfrage erhältlich.

## MATERIAL AND FINISH

Stainless steel frame and base

Satinated or transparent hardened glass table top

## DIMENSIONS (CM)

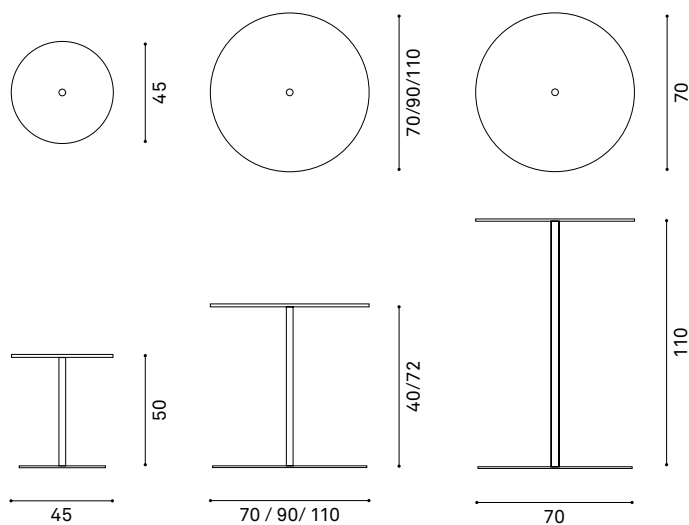

# Team Light Table

DESIGN PETER VAN DE WATER

The minimalist powder coated frame of the Team Light coffee table offers a flawless contrast with its table top. The product was designed to complete the Team seating arrangement, but also mixes easily with many other modern designs.

Die minimalistische, pulverbeschichtete Basis des Team Light Salontisches bietet einen perfekten Kontrast mit dem Tischblatt. Das Produkt wurde entwickelt, um das Team Sitz System zu ergänzen, kombiniert jedoch auch perfekt mit vielen anderen modernen Designs.

## MATERIAL AND FINISH

Powder coated steel frame  
Table top in oak hpl

## COLOUR FRAME



GREY WHITE

## DIMENSIONS (CM)

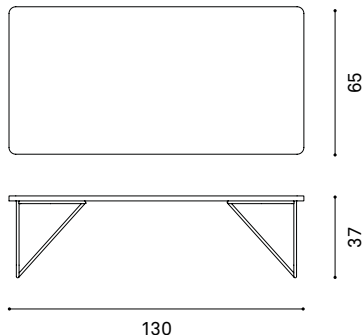

# Paddy

DESIGN PETER VAN DE WATER

Paddy is a side table with a subtle wire frame and a lacquered MDF table top. The white colour and rounded edges of the table top ensure a friendly and accessible look, perfectly matching the Paddy stools.

Paddy ist ein Beistelltisch mit einem subtilen Stahlrahmen und einer lackierten MDF Tischplatte. Die weiße Farbe und abgerundeten Kanten der Tischplatte sorgen für ein freundliches und zugängliches Aussehen, perfekt passend zum Paddy Hocker.

## MATERIAL AND FINISH

Powder coated steel frame  
MDF table top

## COLOUR TOP

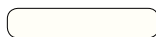

TRAFFIC WHITE

## COLOUR FRAME



GREY WHITE

## DIMENSIONS (CM)

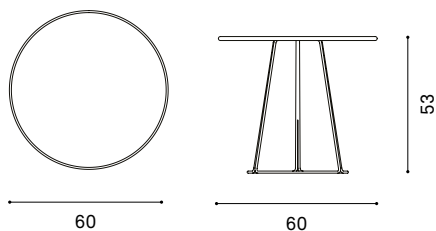

# Rombo

DESIGN EMILIANA DESIGN STUDIO

The pure form, three heights and five matt colours, create endless Rombo-combinations. All parts are carefully crafted, with superb attention to detail. The wooden table top is carefully integrated into the steel frame.

Die geradlinige Form, drei Höhen und fünf matte Farben schaffen endlose Rombo-Kombinationen. Alle Teile werden sorgfältig in Handarbeit, mit viel Liebe zum Detail, verarbeitet. Die Tischplatte aus Esche ist sorgfältig in den Stahlrahmen integriert.

## MATERIAL AND FINISH

Powder coated steel frame  
Ash wood table top

## COLOURS



## DIMENSIONS (CM)

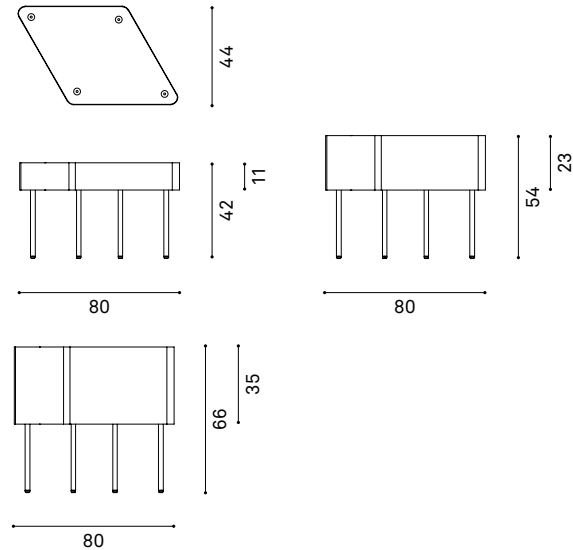



The Furniture Collection  
Stedelijk Museum Amsterdam

# U2 – U2 XL

DESIGN PETER VAN DE WATER

Because of its open shape, it's possible to perfectly slide a U2 side table over a bench or sofa. The multifunctional table is equipped with a convenient magazine rack and can be used either standing up or in a landscape position. The outside is painted matt, the inside has a high gloss finish.

Durch die offene Formgebung kann der Beistelltisch U2 perfekt über eine Sitzbank oder ein Sofa geschoben werden. Dieser multifunktionelle Tisch enthält einen praktischen Zeitschriftenständer und kann stehend oder liegend verwendet werden. Die Außenseite ist matt, die Innenseite hochglänzend.

## MATERIAL AND FINISH

Powder coated steel

## COLOURS



TRAFFIC WHITE



TRAFFIC BLACK

## DIMENSIONS (CM)

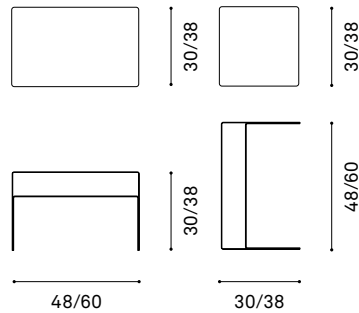



# XL

## DESIGN ONNO DE KNEGT

The base frame made of solid stainless steel characterizes the side tables from the XL series. The base is available with a three- or four-star foot. The table top is made of hardened glass and can be circular or square, and either transparent or satin finished.

Kennzeichnend für die Beistelltische aus der XL-Serie ist das attraktive Untergestell aus massivem Edelstahl. Das Untergestell ist mit einem Drei- oder Viersternfuß lieferbar. Die Tischplatte ist aus gehärtetem Glas, rund oder quadratisch, transparent oder satiniert erhältlich

### MATERIAL AND FINISH

Stainless Steel base

Satinated or transparent hardened glass table top

### DIMENSIONS (CM)

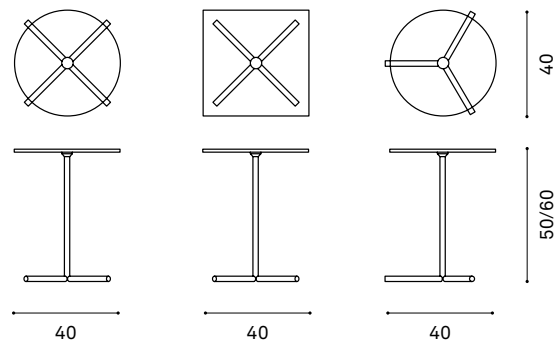

# Exxentrique

DESIGN ONNO DE KNEGT

The eccentric placement of the foot makes it possible to use the Exxentrique table by simply sliding it over a seat. Ideal as a laptop table or as a side table next to a bench. Exxentrique is available with either a round or rectangular table top.

Die exzentrische Platzierung des Ständers macht es möglich die Exxentrique-Tische einfach über eine Sitzfläche zu schieben. Ideal als Laptoptisch oder Beistelltisch. Exxentrique ist erhältlich mit einer runden und rechteckigen Glasplatte.

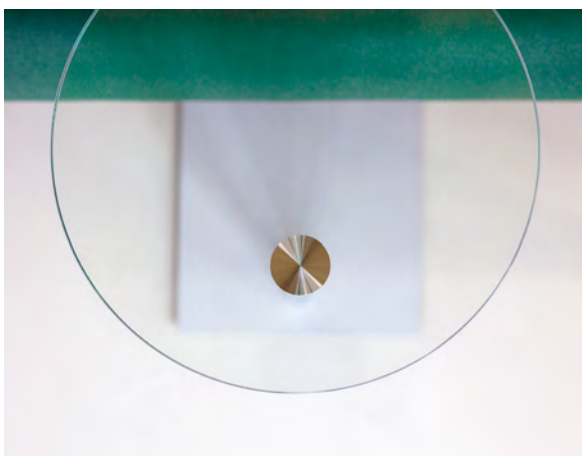

## MATERIAL AND FINISH

Powder coated steel base

Gloss chrome upright

Satinated or transparent hardened glass table top

## DIMENSIONS (CM)

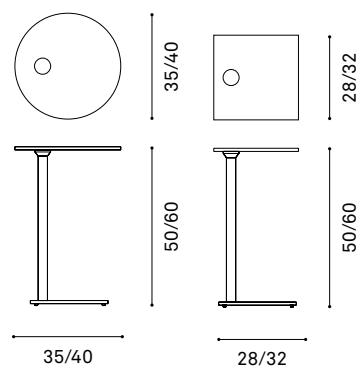

# Platform

DESIGN PETER VAN DE WATER

Platform is a square table that adds a touch of architectural refinement to the interior. The chassis is made from steel wires while the table top comes in powder coated steel.

Platform ist ein quadratischer Tisch, der der Inneneinrichtung einen Hauch architektonischer Raffinesse hinzufügt. Das Gestell besteht aus Stahldraht, die Tischfläche wurde aus pulverbeschichtetem Stahl konstruiert.

## MATERIAL AND FINISH

Steel wire base  
Powder coated steel table top

## COLOURS



TRAFFIC WHITE



TRAFFIC BLACK

## DIMENSIONS (CM)

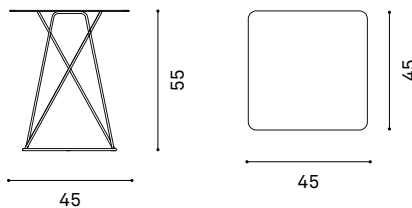

# Frost

DESIGN ROBERT BRONWASSER

The steel base and upright of the Frost side table is finished in a matt white texture paint. The round glass table top is offered in both transparent and satinated finishes.

Die Fußplatte aus Stahl und die Stange sind mit mattweißem Texturlack beschichtet. Die runde Tischplatte aus Glas ist transparent oder satiniert erhältlich.

## MATERIAL AND FINISH

Powder coated steel frame

Hardened satinated or transparent glass table top

## COLOUR



TRAFFIC WHITE

## DIMENSIONS (CM)

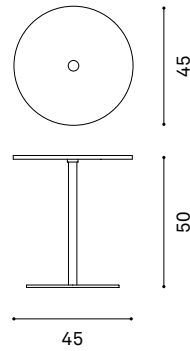



# Display and storage

P. 212-233

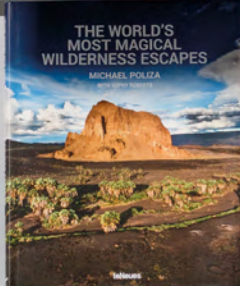

# Round20 Wall

DESIGN ROBERT BRONWASSER

The Round20 brochure holders for wall mounting are available as single brochure holders or as a MDF panel containing five above each other. They are both available in two different widths. The product can be provided with magnets for magnetic mounting on steel walls. Brochure holder depth: 39 mm.

Die Round20 Prospekthalter zur Wandmontage sind als einzelne Prospekt Halter oder als MDF Paneel mit fünf Prospekthaltern übereinander angeordnet erhältlich. Beide sind in zwei verschiedenen Breiten lieferbar. Das Produkt kann auch mit Magneten zur magnetischen Befestigung auf Stahlwänden geliefert werden. Tiefe Prospektablage: 39 mm.

## MATERIAL AND FINISH

Steel panels

## COLOUR



ALUMINIUM

## DIMENSIONS (CM)

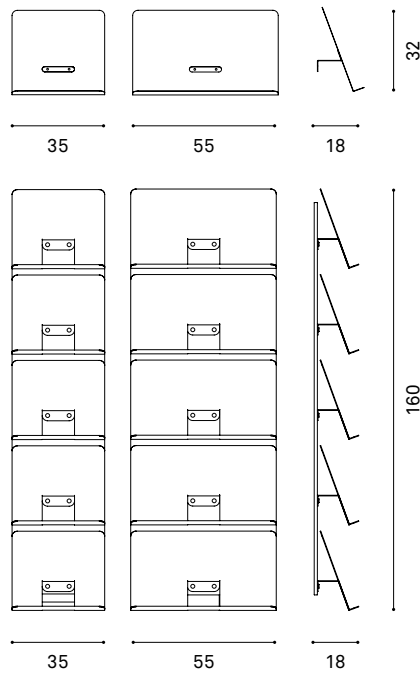





# Round20 Wood

DESIGN ROBERT BRONWASSER

The Round20 brochure frame in wood is available in natural oak, black or white. The brochure holders are available in two different widths and can also be joined together. The casters ensure mobility and the front rollers have brakes. The Round20 series offer multiple accessories such as coat hangers, coat hooks, mirrors, and whiteboard acoustic panels.

Das Round 20 Broschüren Paneel aus Holz ist in natürlicher Eiche, Schwarz oder Weiss erhältlich. Die Prospekt Halter sind in zwei verschiedenen Breiten lieferbar und können auch miteinander kombiniert werden. Die Rollen sorgen für Mobilität wobei die vorderen Rollen bremsbar sind. Die Round20 Serie bietet verschiedene Accessoires wie zum Beispiel Kleiderhänger, Mäntelknöpfe, Spiegel aber auch Whiteboards und akustische Paneele.



## MATERIAL AND FINISH

Wooden uprights  
Casters with brakes  
Anodised aluminium bars  
Powder coated steel panels

## COLOURS

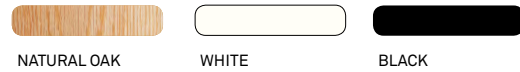

NATURAL OAK

WHITE

BLACK

## DIMENSIONS (CM)

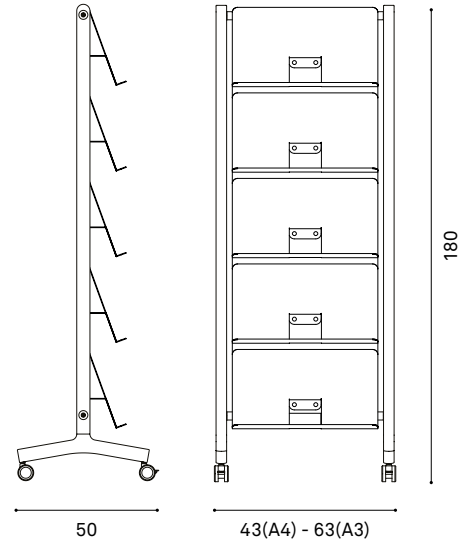

## ADDITIONAL

Brochure holder depth: 39 mm



# Round20 Delta

DESIGN ROBERT BRONWASSER

The Delta brochure stand comes with display panels in two different widths. You can also fit multiple panels side by side between the Delta-elements to achieve the exact capacity you desire.

Der Delta Prospektständer ist mit Display Paneelen in zwei verschiedenen Breiten lieferbar. Man kann auch mehrere Paneele zwischen den Delta Elementen nebeneinander montieren, um die gewünschte Kapazität zu erreichen.



## MATERIAL AND FINISH

Uprights MDF

Anodized aluminium bars

Powder coated steel panels

## COLOUR

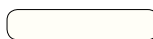

TRAFFIC WHITE

## DIMENSIONS (CM)

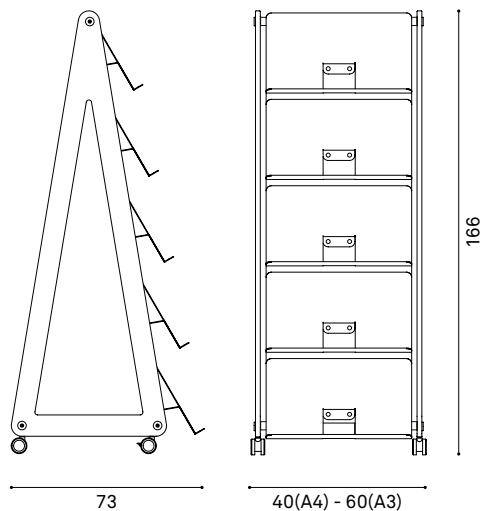

## ADDITIONAL

Brochure holder depth: 39 mm



# Round20 Alu

DESIGN ROBERT BRONWASSER

The Alu element has aluminium uprights (anodized or white) and a steel base. Panels are available in two widths and can be mounted double-sided. By placing multiple panels side by side, the element width is unlimited. Brochure holder depth: 39 mm.

Das Alu-Element hat Ständer aus Aluminium (eloxiert oder Weiß) und ein Untergestell aus Stahl. Die Elemente gibt es in zwei Breiten, die doppelseitig montiert werden können. Durch die Aufstellung mehrerer Elemente nebeneinander ist die Breite des Systems unbegrenzt. Tiefe Prospektablage: 39 mm.

## MATERIAL AND FINISH

Powder coated or aluminium uprights

Anodized aluminium bars

Steel panels

## COLOURS



ALUMINIUM



TRAFFIC WHITE

## DIMENSIONS (CM)

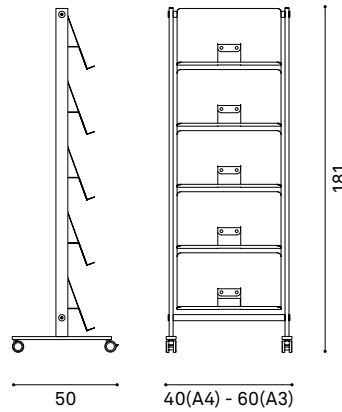

# Leaf

DESIGN ROBERT BRONWASSER

The Leaf magazine or brochure holder forms part of the Nature series. Because of its sturdy shape, it is perfectly suitable to stand on its own in a room. Leaf is stable, can be folded, and is easy to move. Brochure holder depth: 25 mm.

Das Zeitschriftenregal Leaf ist Teil der Nature-Serie. Durch die robuste Form eignet sich Leaf besonders dafür, frei in den Raum gestellt zu werden. Leaf steht stabil, kann zusammengeklappt und problemlos umgestellt werden. Tiefe Prospektablage: 25 mm.

## MATERIAL AND FINISH

Lacquered MDF and aluminium shelves in RAL 9002

## COLOUR



WARM GREY

## DIMENSIONS (CM)

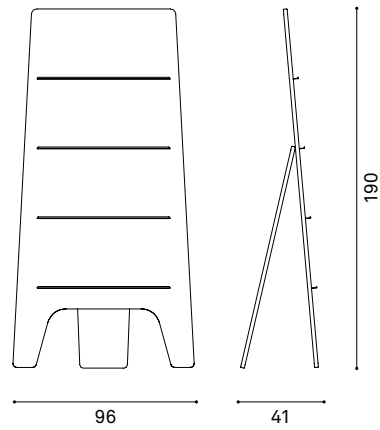

# Focus

DESIGN GERALD BRANDSTÄTTER

The Focus brochure stand is characterized by its round shapes. It has shelves which can be mounted in horizontal or slanted position and which offer ample space for brochures or books. The frame and foot are made of steel and available in a white or silver-grey powder coating.

Der Prospektständer Focus wird gekennzeichnet durch seine abgerundete Form. Focus hat Regale, die horizontal oder schräg montiert werden können und die ausreichend Platz für Broschüren oder Bücher bieten. Der Rahmen und Fuß sind aus Stahl gefertigt und pulverbeschichtet in Weiß oder Silbergrau erhältlich.



## MATERIAL AND FINISH

Steel base and frame

## COLOUR



ALUMINIUM



TRAFFIC WHITE

## DIMENSIONS (CM)

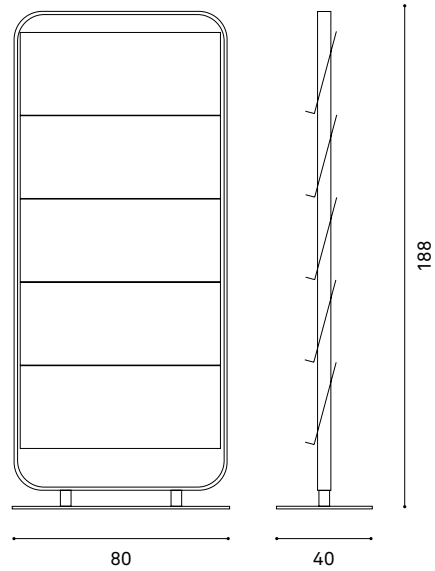

## ADDITIONAL

Brochure holder depth: 34 mm





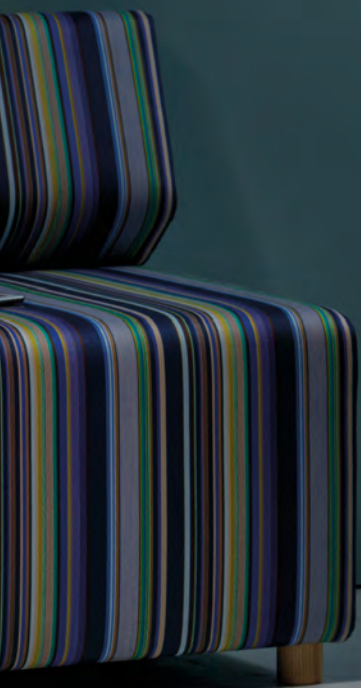

# Frame

DESIGN MARLEEN VALSTAR

The Frame range offers unique wall mounted displays for every space. Frame comes in three different designs. The brochure holder is made of thin-walled aluminium and has a silver-grey lacquer.

Die Frame Serie bietet einzigartige Präsentations-Lösungen für jeden Raum. Frame gibt es in drei verschiedenen Ausführungen. Die Prospekthalter sind aus dünnwandigem Aluminium gefertigt und mit silbergrauem Lack versehen.

## MATERIAL AND FINISH

Powder coated aluminium frame

## COLOUR

ALUMINIUM

## DIMENSIONS (CM)

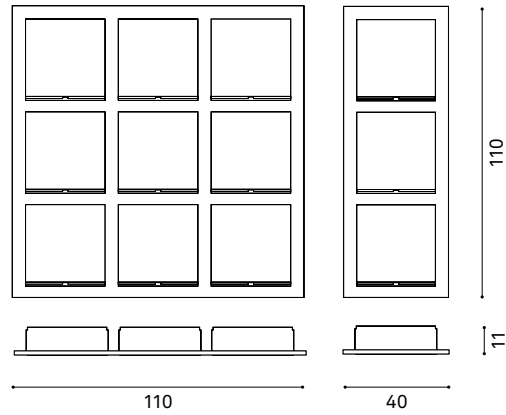

## ADDITIONAL

Brochure holder depth: 25 mm



# Flexible Large

DESIGN ONNO DE KNEGT & MARLEEN VALSTAR

Flexible Large can be used as brochure holder, a book shelf or storage system. The panels are adjustable and can be mounted in either a horizontal or slanted position. Flexible can easily be moved thanks to its small casters. Timeless and well-presented, it is suitable for any environment.

Flexible Large kann eingesetzt werden als Broschürenhalter, Bücherregal oder Aufbewahrungssystem. Die Paneele können sowohl schräg, als auch horizontal angebracht werden. Der Flexible Large kann durch kleine Rollen einfach verstellt werden und ist zeitlos und repräsentativ in jeder Umgebung.



## MATERIAL AND FINISH

Steel base

Aluminium upright and shelves

## COLOUR



ALUMINIUM

## DIMENSIONS (CM)

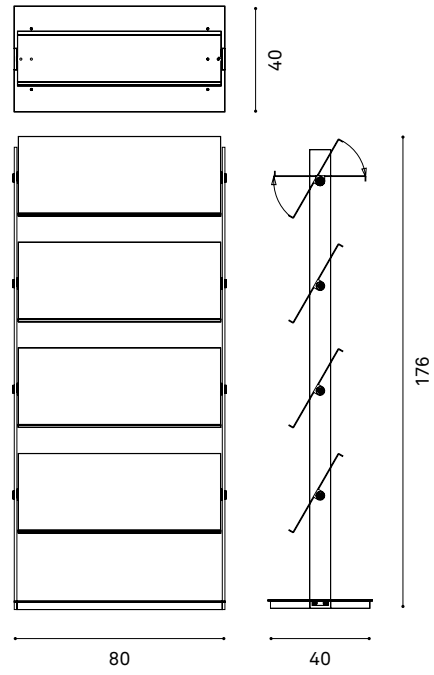

## ADDITIONAL

Brochure holder depth: 40 mm





# Flexible Single & Double

DESIGN ONNO DE KNEGT & MARLEEN VALSTAR

Flexible brochure stands are available in various heights, ranging from one to four panels. The Single version has panels on one side, the Double version has panels on both sides (2 – 8 panels). The panels can be placed either at an angle or horizontally.

Der Prospektständer Flexible ist in verschiedenen Höhen lieferbar, variierend von einem bis vier Paneelen. Die Single Version hat Paneele an einer Seite, die Double Version hat Paneele an beiden Seiten (2 – 8 Paneele). Die Paneele können sowohl horizontal als schräg montiert werden.

## MATERIAL AND FINISH

Steel base

Aluminium upright and shelves

## COLOUR



ALUMINIUM

## ADDITIONAL

Brochure holder depth: 40 mm

## DIMENSIONS (CM)

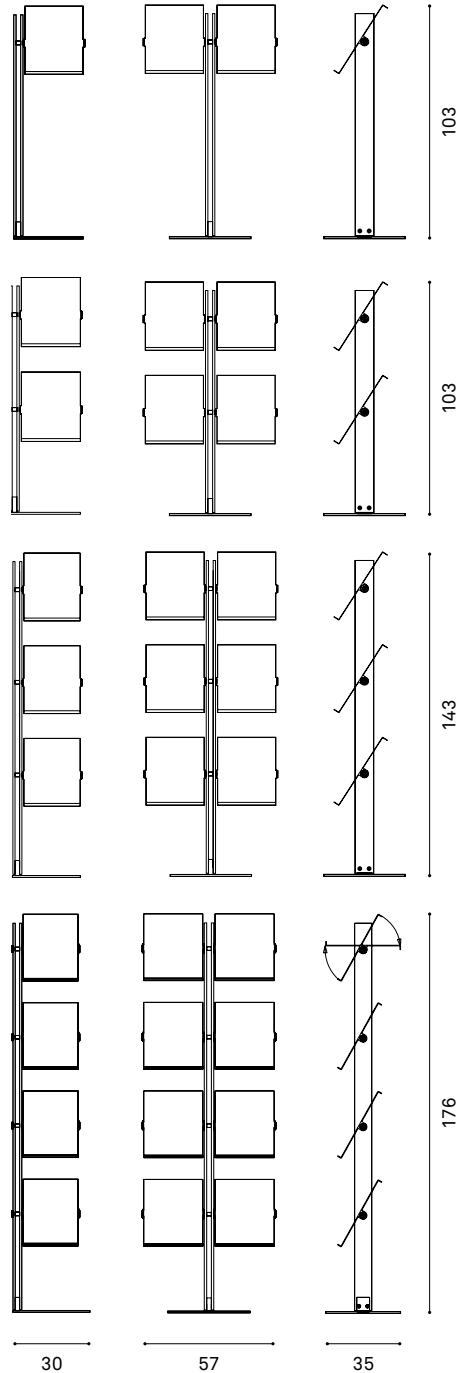

## STANDFREE-BROCHURE

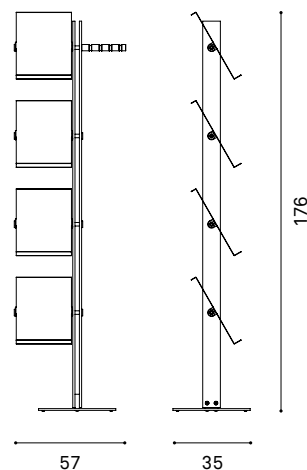

# Pillow Space

DESIGN ROBERT BRONWASSER

The Pillow Space room dividers offer a range of integrated display and storage possibilities. Additionally, the fabric panels are sound absorbing. Magazine holders, shelves and LCD displays, everything is possible. Stability and mobility are ensured by large casters with brakes. Several heights and widths are available.

Die Pillow Space Raumteiler bieten eine Reihe an integrierten Display- und Aufbewahrungsmöglichkeiten. Durch die gepolsterten Paneele sind sie obendrein schallabsorbierend. Prospekthalter, Ablagen und LCD Schirme, alles ist möglich. Stabilität und Mobilität sind gesichert durch große bremsbare Rollen. Die Pillow Space Serie ist in verschiedenen Größen erhältlich.



**MATERIAL AND FINISH**

Powder coated steel shelves  
Upholstered fabric panels  
MDF brochure holders

**ACOUSTIC PROPERTIES**

Standard or premium

**DIMENSIONS (CM)**

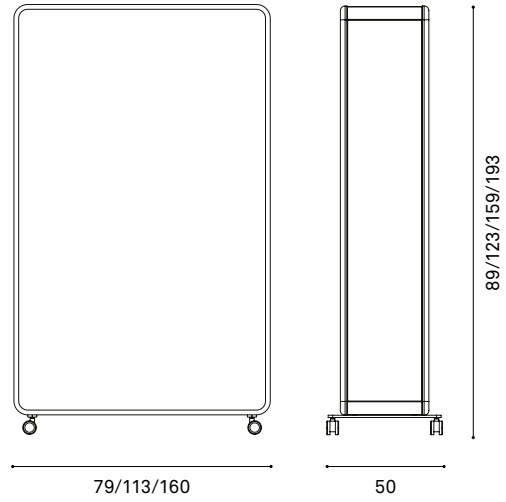

**ADDITIONAL**

Brochure holder steel depth: 33 mm  
Brochure holder MDF depth: 50 mm

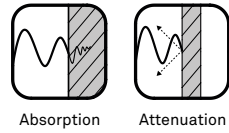



# Box01

DESIGN SILVIO ROHRMOSER





# Box01

DESIGN SILVIO ROHRMOSER

Box01 is a modular storage system, seamlessly welded from thin steel. Box01 can either be mounted on the wall, or be easily stacked thanks to its magnetic feet. Box01 can be ordered with various options such as drawers, shelves and more. The brochure Box has a folding brochure panel and there is storage space for additional brochures. The wall versions can be mounted to the wall in many different ways.

Box01 ist ein modulares Regalsystem gefertigt aus nahtlos geschweißtem dünnem Stahl. Box01 kann an die Wand montiert oder einfach gestapelt werden, wobei magnetische Füße für Stabilität sorgen. Box01 kann mit verschiedenen Optionen wie z. B. Schubladen oder Regalen geliefert werden. Die Brochure Box hat klappbaren Broschürenpaneele, die weiteren Broschüren Platz bieten. Die Wand Version kann auf verschiedene Arten an der Wand montiert werden.

## MATERIAL AND FINISH

Powder coated steel

## COLOUR



ALUMINIUM

## ADDITIONAL

Brochure holder depth: 32 mm

## DIMENSIONS (CM)

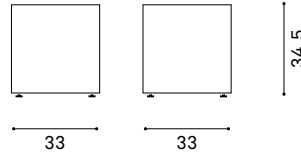

## OPTIONS

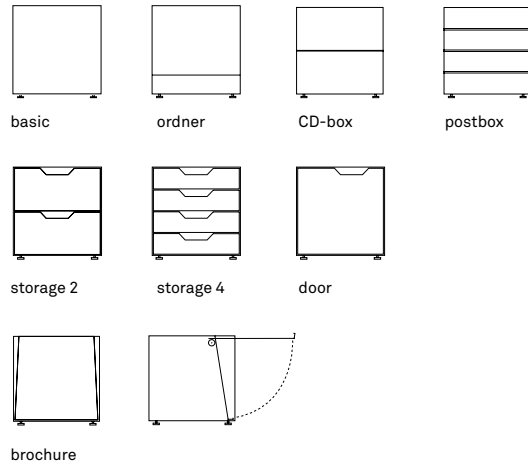





# White boards



# ACTIONS WEEK II

①

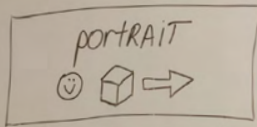

③



②

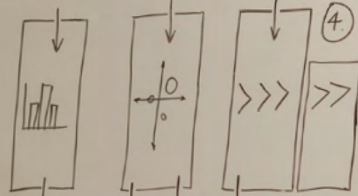
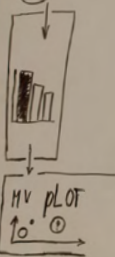

④

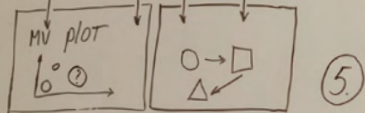

⑤



# Trunk

DESIGN ROBERT BRONWASSER

A mobile whiteboard with a upholstered memo board on the rear. Trunk also acts as a space divider and can be equipped with premium quality sound absorbing PET wool inside. The whiteboards are equipped with a high-quality enamelled steel plate and come in two widths. They are suitable for magnetic accessories. Large wheels with brakes ensure mobility and stability. A felt pocket for storing marker pens is is also included.

Ein mobiles Whiteboard mit einem gepolsterten Memoboard auf der Rückseite. Trunk ist ebenso ein Raumteiler der mit optimal schallabsorbierender PET Wolle angefertigt werden kann. Die Whiteboards sind aus hochwertigen, emaillierten Stahlplatten gefertigt, geeignet für magnetische Accessoires und in zwei Größen lieferbar. Große bremsbare Rollen garantieren Mobilität und Stabilität. Die Filz Tasche für Stifte wird mitgeliefert.

## MATERIAL AND FINISH

Enamelled steel sheet whiteboard

Upholstered back side

Steel base with casters

## DIMENSIONS (CM)

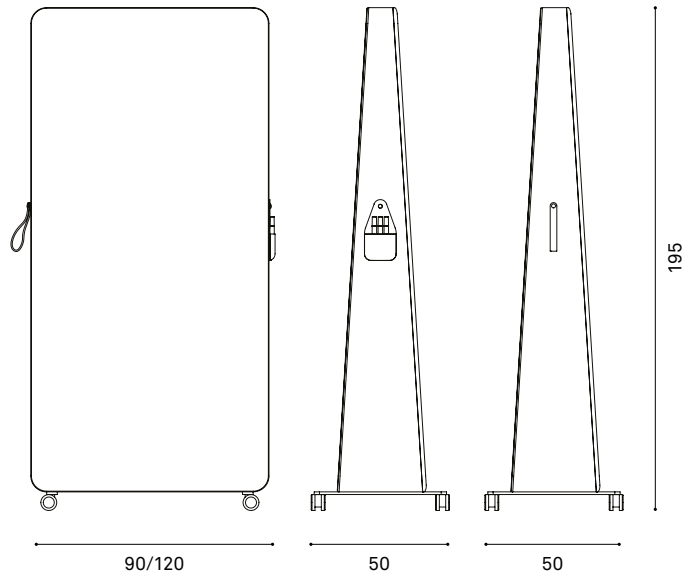

## ADDITIONAL

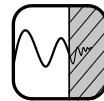

Absorption

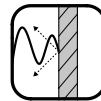

Attenuation





pizza Run

WIDE-SCREEN T.V.

salsa

MIDDLE SCREEN

adjust REMOTE

chips

dip

EXTRA CASE  
of  
TWO-FOUR



# Leaf

DESIGN ROBERT BRONWASSER

The Leaf white board forms part of the Nature series. Because of the sturdy shape it is ideal for standing free in a room. Leaf is stable, can be folded and is easily moved. The magnetic whiteboard is made of high quality enamelled steel. The aluminium shelf offers space for pens and paper.

Das Leaf Whiteboard ist Teil der Nature-Serie. Durch die robuste Form eignet sich Leaf besonders dafür, frei in den Raum gestellt zu werden. Leaf steht stabil, kann zusammengeklappt und problemlos umgestellt werden. Das Whiteboard ist magnetisch und hat eine Oberfläche aus hochwertigem, emailiertem Stahl. Die Aluminiumleiste bietet Platz für Stifte und Papier.

## MATERIAL AND FINISH

Enamelled steel sheet whiteboard

MDF

Aluminium shelf in RAL 9002

## COLOURS



WARM GREY

## DIMENSIONS (CM)

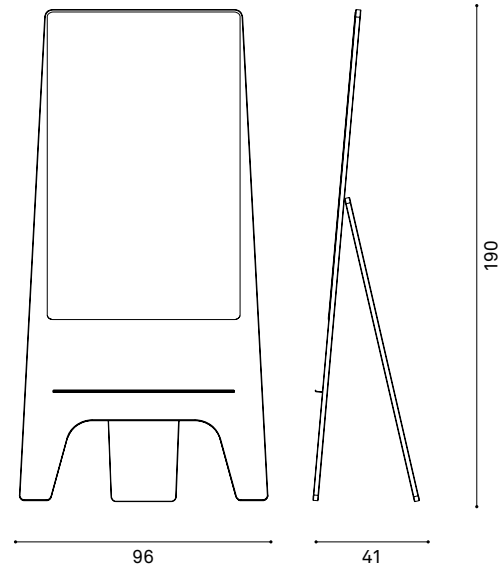



# Pillow Grid

DESIGN ROBERT BRONWASSER

Pillow Grid whiteboards are part of the Pillow series. These magnetic whiteboards have a surface of hardened glass and are available in various sizes. Optional accessories such as a magnetic felt pocket for storing marker pens, a flip chart holder, erasers, markers and magnets complete the design.

Pillow Grid Whiteboards sind Teil der Pillow Serie. Die magnetischen Whiteboards haben eine Oberfläche aus gehärtetem Glas. Die Tafeln gibt es in verschiedenen Größen. Optionelle Accessoires, wie eine magnetisch Filz Tasche für Stifte, einen Flipcharthalter, Wischer, Stifte und Magnete machen das Design komplett.

## MATERIAL AND FINISH

Tempered glass with steel back plate

## SUSPENSION

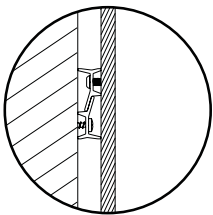

## DIMENSIONS (CM)

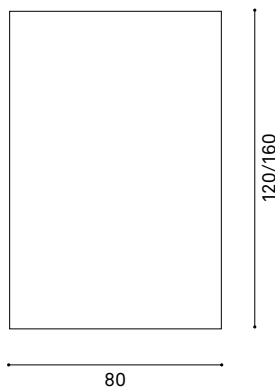
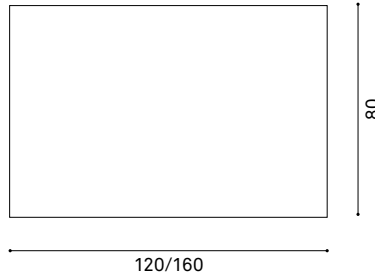
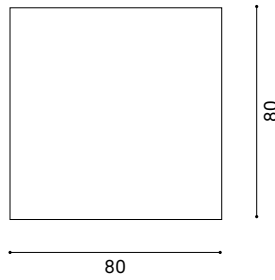

TEAM A

- \* Jimmy
- \* Marc
- \* Steven
- \* Bob
- \* Tim
- \* Dexter
- \* Lucas
- \* Sam



FOCUS!

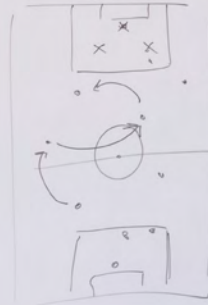

Debra  
Alison

# Pillow Space

DESIGN ROBERT BRONWASSER

The Pillow Space room dividers offer a range of whiteboards as well. There are two versions; either the total front can be equipped with a enamelled steel whiteboard or the front can be equipped with a glass surface whiteboard from the Pillow Grid series (previous page). Both are magnetic and stability and mobility are ensured by large casters with brakes. Several heights and widths are available and easy configuration with shelves, wardrobe or other accessories is possible (see Pillow Space pages).

Die Pillow Space Raumteiler werden auch mit Whiteboards geliefert. Es gibt zwei Versionen; die gesamte Front wird in einem emailliertem Whiteboard aus Stahl ausgeführt oder Pillow Space wird mit einem gläsernem Whiteboard aus der Pillow Grid Serie (vorige Seite) versehen. Beide sind magnetisch und in diversen Größen verfügbar. Stabilität und Mobilität sind durch große bremsbare Rollen gesichert. Die Konfiguration mit Regalen, Garderoben und anderen Accessoires ist möglich (siehe Pillow Space Seiten).

## MATERIAL AND FINISH

Enameled steel sheet whiteboard or glass whiteboard  
Upholstered panels

## DIMENSIONS (CM) STEEL WHITEBOARD

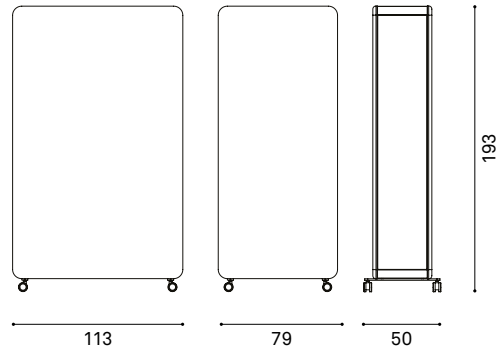

## DIMENSIONS (CM) GLASS WHITEBOARD

See previous page.

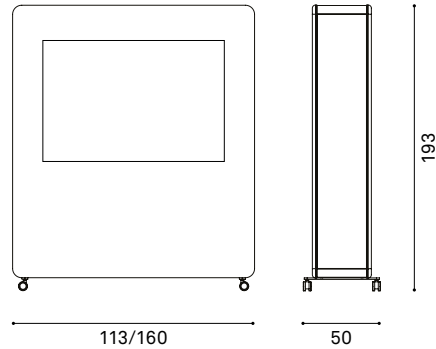

## ADDITIONAL

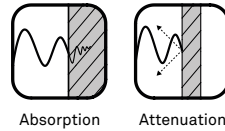

WHEN

MATCH

Group

| WHEN         | MATCH              | Group |
|--------------|--------------------|-------|
| 18 aug 20.00 | NL - SPAIN         | A     |
| 19 aug 10.15 | GERMANY - UK       | B     |
| 20 aug 11.00 | Belgium - Scotland | B     |
| 20 aug 17.45 | Tjechië - NL       | A     |
| 22 aug 12.30 | UK - Germany       | B     |
| 24 aug 10.00 | Scotland - NL      | B     |
| 24 aug 17.30 | ITALIE - SPAIN     | A     |



# Round20 Wall

DESIGN ROBERT BRONWASSER

The Round20 Wall whiteboards have a surface of high-quality enamelled steel plate. They are magnetic and available in various sizes. Optional accessories such as a magnetic felt pocket for storing marker pens, a flip chart holder, erasers, markers and magnets complete the design. The whiteboards can be equipped with magnets for steel walls.

Round20 Wall Whiteboards haben eine Oberfläche aus hochwertigem emailliertem Stahl. Die Tafeln sind magnetisch und in verschiedenen Größen verfügbar. Optionelle Accessoires wie eine magnetisch Filz Tasche für Stifte, ein Flipcharthalter, Wischer, Stifte und Magnete machen das Design komplett. Die Whiteboards können für die Anwendung auf Stahlwänden mit Magnethalterung geliefert werden.

## MATERIAL AND FINISH

Enamelled steel sheet whiteboard

## SUSPENSION

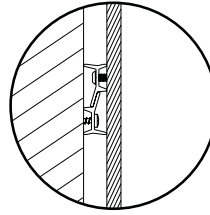

## DIMENSIONS (CM)

Landscape or portrait

82X112

82X160

112X160

112X112

152x160

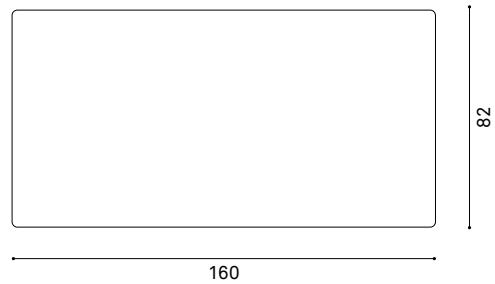





# Round20

DESIGN ROBERT BRONWASSER

The modular Round20 element frames can all be fitted with the enamelled steel Round20 whiteboard, which comes in three widths. The framework allows highly functional, double-sided combinations e.g. whiteboard / whiteboard, whiteboard / memoboard, whiteboard / acoustic panel. If using the Delta element, the whiteboard will be placed at a bevelled angle.

Die modulare Round20 Rahmen-Elemente können mit dem Round20 Whiteboard aus emailliertem Stahl, das in drei Breiten erhältlich ist, ausgestattet werden. Die Rahmen-Elemente können auch in doppelseitiger Kombination ausgeführt werden, welche sehr funktionell sind: Whiteboard / Whiteboard, Whiteboard / Memoboard, Whiteboard / Akustisches Paneel. Im Falle des Delta-Elements wird das Whiteboard in einem schrägen Winkel platziert.



MATERIAL AND FINISH  
Frame in wood or aluminium

## COLOURS

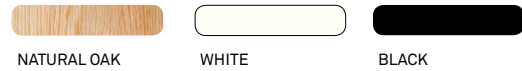

## DIMENSIONS (CM)

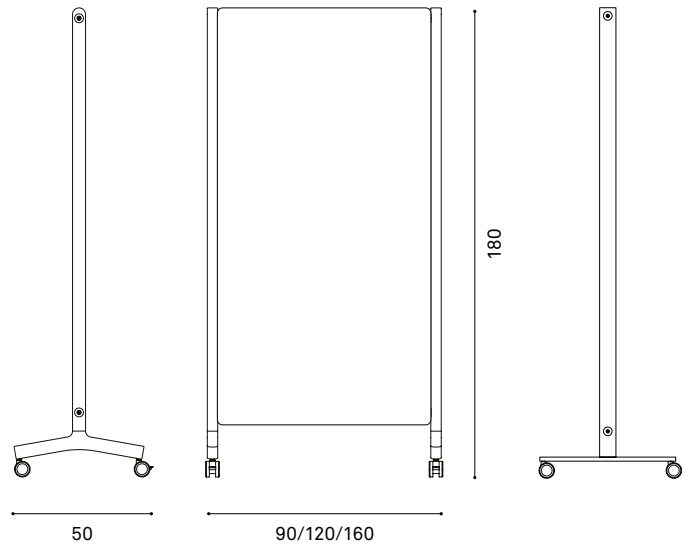

## COMBINATIONS

- whiteboard / whiteboard
- whiteboard / memoboard
- whiteboard / acoustic panel







# Planters

P. 250-251

# Pillow Space

DESIGN ROBERT BRONWASSER

Pillow Space planters make it possible to integrate nature in sound absorbing office designs. The planter is part of the large family of Pillow Space room dividers in which acoustic solutions meet various other functions. Available in three widths. The casters have brakes and a rubber insert is included.

Mit den Pflanzengefäßen der Pillow Space Serie integrieren Sie die Natur in Ihr schallabsorbierendes Office Design. Der Pflanzenhalter ist Teil der großen Pillow Space Raumteiler Familie, die akustische Lösungen mit verschiedenen anderen Funktionen verbindet. Lieferbar in drei Breiten. Auf Rollen, wobei die Vorderen bremsbar sind. Ein Gummi Einsatz wird mitgeliefert.

## MATERIAL AND FINISH

Powder coated steel, upholstered panels

## DIMENSIONS (CM)

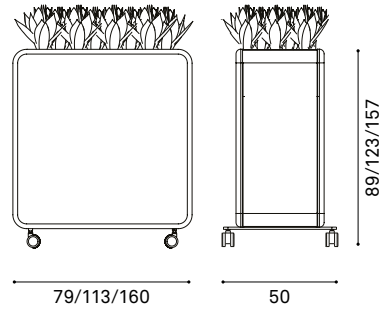

## ADDITIONAL

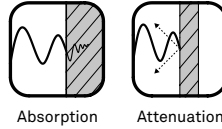

# Rombo

DESIGN EMILIANA DESIGN STUDIO

In combination with different heights and colours, the diamond shape of Rombo allows many different configurations. A Rombo seat and table make it possible to enjoy the planters from very nearby. All the parts are carefully crafted, with superb attention to detail and a rubber insert is also included. Mix and match all objects to create a living ecosystem.

Die Rombo Form in verschiedenen Höhen und Farben macht viele Konfigurationen möglich. Ein Rombo Sitz und Tisch ermöglicht es, die Pflanzen von sehr nahe zu genießen. Alle Teile werden sorgfältig in Handarbeit, mit viel Liebe zum Detail, verarbeitet. Ein Gummi Einsatz wird mitgeliefert. Mischen Sie alle Objekte zu einem lebendigen Ökosystem.

## MATERIAL AND FINISH

Powder coated steel frame

Ash wood table top

## COLOURS



CITRON YELLOW



YELLOW GREY



QUARTZ GREY

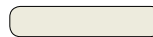

GREY WHITE

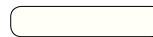

TRAFFIC WHITE

## DIMENSIONS (CM)

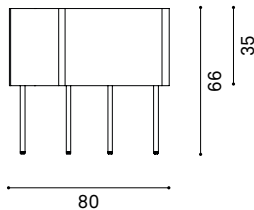
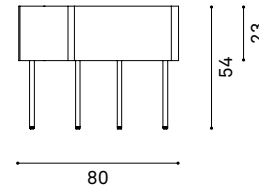
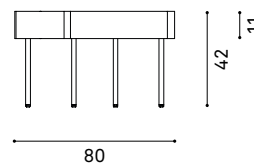
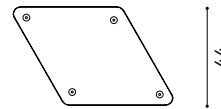



# Umbrella stands

P. 254-261



# Flow I

DESIGN MARLEEN VALSTAR

A functional design icon for each entrance. Completely made of steel, seamless finished and optionally fitted with an insert container for short umbrellas.

Eine funktionelle Designikone für jeden Eingangsbereich. Vollständig hergestellt aus Stahl, nahtlos verarbeitet und wahlweise erhältlich mit einem Einsatz für Taschenschirme.



## MATERIAL AND FINISH

Powder coated steel

## COLOURS



BLANC ALUMINIUM



TRAFFIC WHITE

## DIMENSIONS (CM)

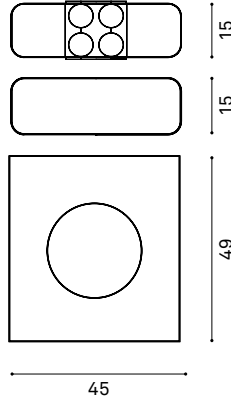

# Square - Flow II

DESIGN MARLEEN VALSTAR

Square is a sleek, high umbrella stand with clean-cut square corners made of steel. Flow II is a tall umbrella stand with attractive rounded edges. Made of steel with a perfect seamless finish.

Square ist ein schlanker, hoher Schirmständer mit rechten Winkeln. Flow II ist ein hoher Schirmständer mit abgerundeten Ecken. Beide Schirmständer sind aus Stahl gefertigt, und perfekt nahtlos verarbeitet.



## MATERIAL AND FINISH

Powder coated steel

## COLOURS



ALUMINIUM



TRAFFIC WHITE

## DIMENSIONS (CM)

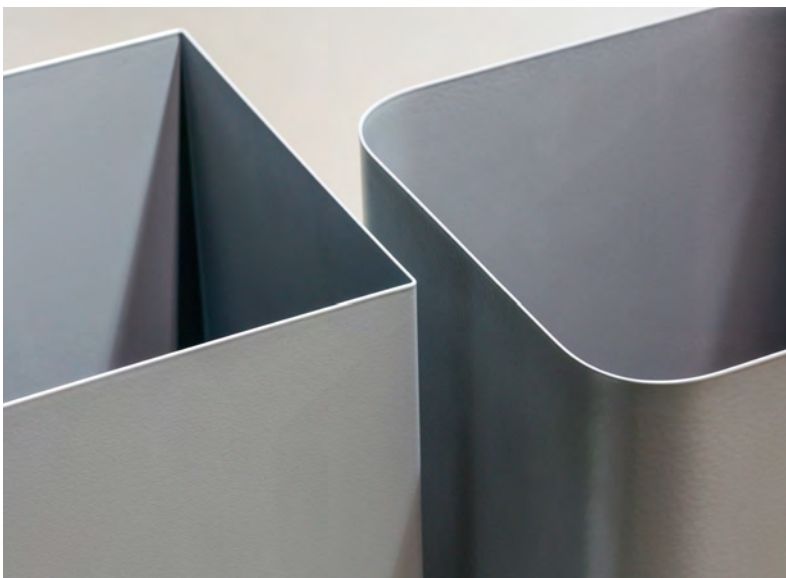
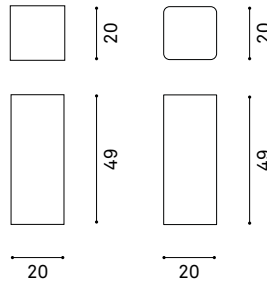

# Round20

DESIGN ROBERT BRONWASSER

The umbrella stand from the Round20 series is made of anodised aluminium with a steady steel base. The removable magnetic drip catcher, made of black rubber, is easy to clean.

Der Schirmständer aus der Round20-Serie ist aus anodisiertem Aluminium gefertigt und wird mit einem stabilen Stahlfuß geliefert. Der abnehmbare, magnetische Tropfenfänger aus schwarzem Gummi ist einfach zu reinigen.

## MATERIAL AND FINISH

Powder coated steel base  
Anodised aluminium frame

## COLOUR



ALUMINIUM

## DIMENSIONS (CM)

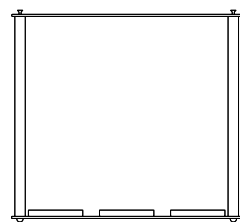

55

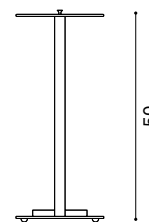

50

21



# Standin

DESIGN ONNO DE KNEGT & PETER VAN DE WATER

The clear design and combination of polished aluminium and matt silver grey gives Standin its own identity. Standin has a removable magnetic drip tray which ensures easy cleaning.

Die klare Gestaltung und die Kombination aus poliertem Aluminium und mattem Silbergrau geben Standin eine eigene Identität. Standin hat eine abnehmbare, magnetische Tropfschale, die eine einfache Reinigung ermöglicht.

## MATERIAL AND FINISH

Polished aluminium stand  
Powder coated steel holder and base

## COLOURS



ALUMINIUM

## DIMENSIONS (CM)

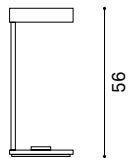
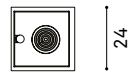

# Velvet

DESIGN MARLEEN VALSTAR

The Velvet umbrella stand can hold seven umbrellas and easily catches all the drips. This effective stand is made of anodised aluminium.

Der Schirmständer Velvet bietet Platz für sieben Regenschirme und fängt mühelos die Tropfen auf. Vollständig aus anodisiertem Aluminium hergestellt.

## MATERIAL AND FINISH

Anodised aluminium stand

## DIMENSIONS (CM)

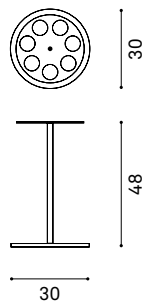

# Flower

DESIGN ROBERT BRONWASSER

Beautifully lined umbrella stand with a holder from PMMA and a stable cast iron base with integrated drip box. Among the large hooks are smaller loop hooks, which are suitable to hang foldable umbrellas.

Wunderschön entworfener Schirmständer mit einem Halter aus Polyamide und einem stabilen Fuß aus Gusseisen mit integrierter Tropfschale. Zwischen den großen Schlaufenhaken befinden sich kleinere Haken für das Aufhängen von Knirpsen.

## MATERIAL AND FINISH

Polyamide crown

Powder coated steel tube

Powder coated cast iron base

## COLOURS



## DIMENSIONS (CM)

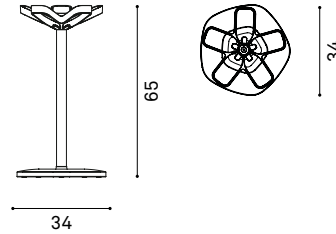



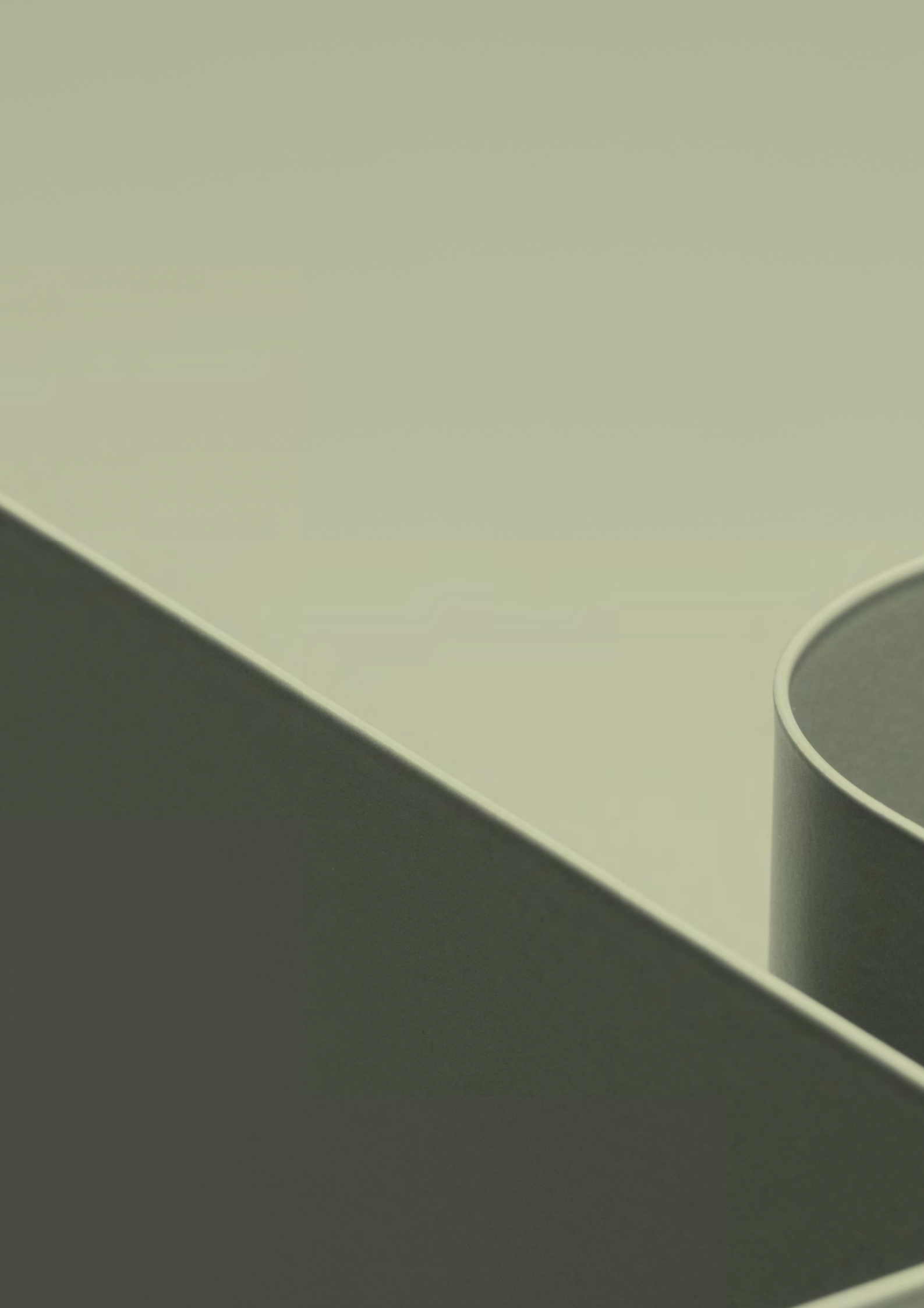

# Paper bins

P. 264-267



# Flow

DESIGN MARLEEN VALSTAR

Flow waste bins have attractive rounded corners. They are made of steel with a perfect finish and are leakproof. Available in three sizes and two colours. Special colours are available on request.

Flow-Papierkörbe haben attraktive runde Ecken. Sie sind aus Stahl, perfekt verarbeitet und tropfdicht. Lieferbar in drei Maßen und zwei Farben. Sonderfarben sind möglich.

## MATERIAL AND FINISH

Powder coated steel

## COLOURS



ALUMINIUM

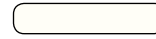

TRAFFIC WHITE

## DIMENSIONS (CM)

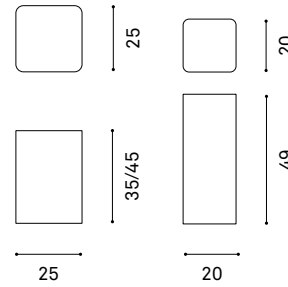

# Square

DESIGN CASCANDO STUDIO

The waste bins from the Square series have square corners and simple lines. They are meticulously finished in thin-walled steel and are leakproof. Available in three sizes and two colours. Can be supplied with a cover ring if required. Special colours are available on request.

Die Papierkörbe aus der Square-Serie haben gerade Ecken und gerade Linien. Sie werden sorgfältig in dünnwandigem Stahl verarbeitet und sind tropfdicht. Lieferbar in drei Größen und zwei Farben. Falls gewünscht mit Abdeckring. Sonderfarben sind möglich.



## MATERIAL AND FINISH

Powder coated steel

## COLOURS



ALUMINIUM



TRAFFIC WHITE

## DIMENSIONS (CM)

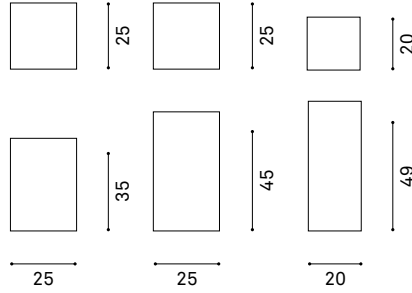

# Fabrics







## FURNITURE FABRICS

- High quality fabrics, suitable for contract furniture
- Furniture fabrics are also suitable for panels up to 120cm wide or wider with a seam
- Other fabrics or customer own material on request

| CAT. | BRAND         | FABRIC           |
|------|---------------|------------------|
| A    | Camira        | Urban            |
| A    | Camira        | Xtreme           |
| A    | Gabriel       | Medley           |
| A    | Gabriel       | Go Check         |
| B    | Kvadrat       | Umami            |
| B    | Gabriel       | Interglobe Wool  |
| B    | Camira        | Mainline Flax    |
| B    | Kvadrat       | Revive 1,2       |
| B    | Gabriel       | Step Melange     |
| C    | Kvadrat       | Remix            |
| C    | Kvadrat       | Hero             |
| C    | Camira        | Synergy          |
| C    | Camira        | Blazer           |
| C    | Serge Ferrari | Stamskin Top     |
| C    | Vyva Fabrics  | Sylverguard      |
| D    | Kvadrat       | Divina 3         |
| D    | Kvadrat       | Divina Melange 2 |
| D    | Kvadrat       | Hallingdal 65    |
| D    | Kvadrat       | Steelcut 2       |
| D    | Kvadrat S     | Teelcut trio 3   |

## LEGENDA ICONS

|  |                 |
|--|-----------------|
|   | acoustic tested |
|   | fire retardant  |
|   | waterproof      |
|   | stain resistant |
|   | healthcare      |
|   | Trevira CS      |
|   | upholstery      |
|   | panel fabric    |
|   | recyclable      |
|  | ecologic        |

## PANEL FABRICS

- High quality fabrics, exclusively suitable for panels
- Panel fabrics with matching furniture fabrics: Blazer lite, Floyd screen, Synergy 170
- Other fabrics or customer own material on request

| CAT. | BRAND   | FABRIC        |
|------|---------|---------------|
| P0   | Camira  | Cara          |
| P1   | Gabriel | Soul          |
| P1   | Camira  | Racer         |
| P1   | Gabriel | Twist Melange |
| P2   | Camira  | Blazer Lite   |
| P2   | Kvadrat | Floyd Screen  |
| P2   | Camira  | Synergy 170   |

## COLOURS

Colours can differ from image, for a true colour perspective and up to date colour card, please visit the brand website.



# Camira Urban | category A

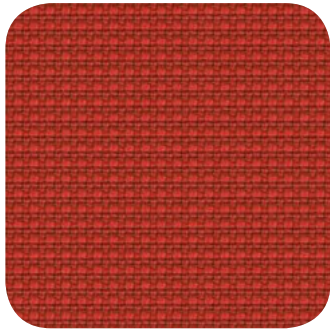

## Application

Task seating

## Composition

100% Recycled Flame Retardant Polyester

Non metallic dyestuffs

## Environmental

EU Ecolabel, Oeko-Tex Standard 100

Made from 100% recycled polyester

## Width

140cm minimum

## Weight

340 g/m<sup>2</sup> ±5% (480 g/lin.m ±5%)

## Flame resistance

EN 1021 - 1 (cigarette)

EN 1021 - 2 (match)

BS 7176 Low Hazard

BS 5852 Ignition Source 5

BS 7176 Medium Hazard

DIN 4102 B1

UNI 9175 Classe 1 IM

## Abrasion resistance

100,000 Martindale cycles

## Fastness to Rubbing

Wet: 4, Dry: 4 (ISO 105 - X12)

## Cleaning

Washable to 60 °C. Vacuum regularly.

Wipe clean with a damp cloth or shampoo using proprietary upholstery shampoo.

## Colours

Colours can differ from image, for a true colour perspective and up to date colour card, please visit the brand website.



YN108



YN212



YN082



YN158



YN148



YN027



YN076



YN079



YN203



YN211



YN201



YN086



YN204



YN205



YN210



YN082



YN202



YN209



YN208



YN097



YN094



YN206



YN207



YN083



YN145



YN009



YN190



YN160



YN159



YN200

# Camira Xtreme | category A

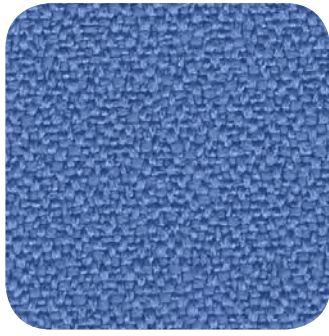

## Application

Task seating

## Composition

100% Recycled Flame Retardant Polyester

Non metallic dyestuffs

## Environmental

EU Ecolabel, Oeko-Tex Standard 100

Made from 100% recycled polyester

## Width

140 cm minimum

## Weight

310 g/m<sup>2</sup> ±5% (435 g/lin.m ±5%)

## Flame resistance

EN 1021 - 1 (cigarette)

EN 1021 - 2 (match)

BS 7176 Low Hazard

BS 5852 Ignition Source 5

BS 7176 Medium Hazard

DIN 4102 B1

NF D 60-013

ÖNORM B 3825 & A 3800-1  
(over 58 kg/m<sup>3</sup> CMHR foam)

UNI 9175 Classe 1 IM

BS 476 Part 7 Class 1

## Abrasion resistance

100,000 Martindale cycles

## Fastness to Rubbing

Wet: 4, Dry: 4 (ISO 105 - X12)

## Cleaning

Washable to 60 °C. Vacuum regularly.

Wipe clean with a damp cloth or shampoo  
using proprietary upholstery shampoo.

## Colours

Colours can differ from image,  
for a true colour perspective  
and up to date colour card,  
please visit the brand website.



# Gabriel Medley | category A



## Application

Contract and soft seating

## Composition

100% polyester

## Environmental

Oeko-Tex, 100% free of heavy metals

## Width

140cm

## Weight

510 g/lm

16.45 oz/lin.yd

## Flame resistance

BS EN 1021 1&2 Cigarette and Match

BS EN 1021-1 Cigarette

BS 5852 Part 1 0,1 Cigarette & match

BS 476 Part 7, class 2

Class Uno UNI 9175 Class 1 | EMME

Class Uno UNI 9174 - UNI 8457

ÖNORM B 3825-B2-3800-Q1 UK

CA TB 117-2013

ASTM E 84

## Abrasion resistance

75,000 Martindale cycles

## Fastness to Rubbing

4-5/4-5 scale 1-5, max. 5 -

EN ISO 105x12 (wet/dry)

## Cleaning

Wash and dry cleaning P(W).

## Colours

Colours can differ from image,  
for a true colour perspective  
and up to date colour card,  
please visit the brand website.



60999



61004



60004



60167



61002



61003



67002



62054



62002



68005



68002



68114



68115



67054



67053



67006



67052



66144



66009



66008



66010



66007



66145



65086



65012



65011



64125



64124



63064



61189



63063



63017



64123



64123



64019



63013

# Gabriel Go Check | category A

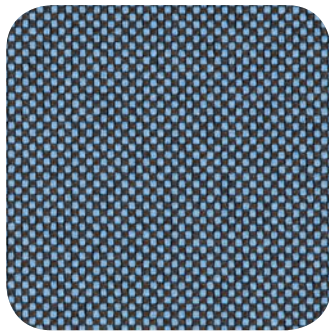

## Application

Contract

## Composition

100% Trevira cs

## Environmental

Oeko-Tex, EU Ecolabel

Cradle to Cradle Bronze,

100% free of heavy metals

## Width

140cm

## Weight

435 g/lm

14.03 oz/lin.yd

## Flame resistance

BS EN 1021 1&2 Cigarette and Match

BS EN 1021-1 Cigarette

BS 5852 Part 1 0,1 Cigarette & match

BS 5852 Crib 5

BS 7176 Medium hazard

DIN 4102 B1

NFP 92-503/504/505 M1

ÖNORM B 3825-B1-3800-Q1 UK

Class Uno UNI 9175 Class 1 I EMME

FAR/JAR 25.853 (a) (i) (ii)

CA TB 117-2013

DIN EN 13501-1 B-s1,d0

## Abrasion resistance

80,000 Martindale cycles

## Fastness to Rubbing

-5/4-5 scale 1-5, max. 5 -

EN ISO 105x12 (wet/dry)

## Cleaning

Wash or dry cleaning P(W).

## Colours

Colours can differ from image,

for a true colour perspective

and up to date colour card,

please visit the brand website.



# Kvadrat Umami | category B



## Application

Upholstery

## Composition

90% wool and 10% nylon

## Width

140cm

## Weight

app. 420 g/lin.m

## Flame resistance

EN 1021-1/2

BS 5852 part 1

NF D 60 013

UNI 9175 1IM

US Cal. Bull. 117-2013

IMO A.652 (16)

## Abrasion resistance

80,000 Martindale cycles

## Cleaning

Vacuuming and dry cleaning.

## Colours

Colours can differ from image,  
for a true colour perspective  
and up to date colour card,  
please visit the brand website.



0231



0621



0251



0471



0871



0181



0191



0851



0721



0111



0761



0651



0731



0711



0221



0611



0551



0441



0661

# Gabriel Interglobe Wool 2 |category B



## Application

Contract

## Composition

100% wools of New Zealand

## Environmental

Oeko-Tex, EU Ecolabel

100% free of heavy metals

## Width

140cm

## Weight

620 g/lm

20.00 oz/lin.yd

## Flame resistance

BS 7176 Medium hazard

BS 5852 Crib 5

IMO MSC 307(88) Annex 1 part 8

MED Certificate IMO

BS EN 1021 1&2 Cigarette and Match

BS 5852 Part 1 0,1 Cigarette & match

CA TB 117-2013

## Abrasion resistance

50,000 Martindale cycles

## Fastness to Rubbing

4/4 Scale 1-5, max. 5 -

EN ISO 105x12 (wet/dry)

## Cleaning

Dry cleaning P(S).

## Colours

Colours can differ from image,  
for a true colour perspective  
and up to date colour card,  
please visit the brand website.



# Camira Mainline flax | category B



## Application

Task seating, soft seating and curtain

## Composition

70% Virgin Wool and 30% Flax

## Environmental

Certified to the EU Ecolabel  
Rapidly renewable and compostable

Made from wool and bast fibre

## Width

140cm

## Weight

435 g/m<sup>2</sup> ±5% (610 g/lin.m ±5%)

## Flame resistance

EN 1021 - 1 (cigarette)

EN 1021 - 2 (match)

BS 7176 Low Hazard

BS 5852 Ignition Source 5

BS 7176 Medium Hazard

NF D 60-013

ÖNORM B 3825 & A 3800-1

(58kg/m<sup>3</sup> CMHR Foam)

UNI 9175 Classe 1 IM

BS 5867-2: Type B Curtains & Drapes

## Abrasion resistance

50,000 Martindale cycles

## Fastness to Rubbing

Wet: 3, Dry: 4 (ISO 105 - X12)

## Cleaning

Vacuum regularly. Professionally dry clean or wipe clean with a damp cloth.

## Colours

Colours can differ from image, for a true colour perspective and up to date colour card, please visit the brand website.



MLF10



MLF09



MLF24



MLF21



MLF22



MLF25



MLF37



MLF34



MLF35



MLF38



MLF05



MLF19



MLF36



MLF28



MLF32



MLF29



MLF18



MLF30



MLF07



MLF20



MLF12



MLF15



MLF15



MLF17



MLF13



MLF08



MLF03



MLF01



MLF06



MLF14



MLF41



MLF11



MLF04



MLF33



MLF27



MLF40



MLF39



MLF23



MLF02



MLF26



MLF16

# Kvadrat Revive 1 | category B

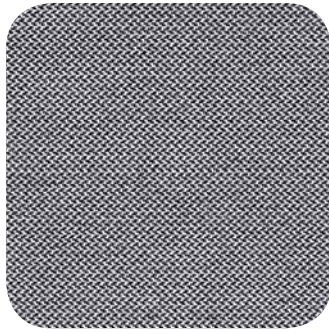

**Application**

Upholstery

**Composition**

100% recycled polyester FR

**Environmental**

Recycled resource from PET bottles

**Width**

App. 140 cm

**Weight**

App. 430/lin.m

**Flame resistance**

EN 1021-1/2

DIN 4102 B1

Önorm B1/Q1

UNI 9175 1IM

US Cal. Tech. Bull. 117

IMO A.652 (16)

**Abrasion resistance**

60,000 Martindale cycles

**Cleaning**

Vacuuming and dry cleaning.

**Colours**

Colours can differ from image, for a true colour perspective and up to date colour card, please visit the brand website.





# Kvadrat Revive 2 | category B



## Application

Upholstery

## Composition

100% recycled polyester FR

## Environmental

Recycled resource from PET bottles

## Width

App. 140 cm

## Weight

App. 420/lin.m

## Flame resistance

EN 1021-1/2

DIN 4102 B1

Önorm B1/Q1

UNI 9175 1IM

US Cal. Tech. Bull. 117

IMO A.652 (16)

## Abrasion resistance

60,000 Martindale cycles

## Cleaning

Vacuuming and dry cleaning.

## Colours

Colours can differ from image,  
for a true colour perspective  
and up to date colour card,  
please visit the brand website.



0133



0323



0163



0153



0173



0973



0373



0183



0193



0166



0663



0633



0523



0433



0453



0223



0923



0833



0753



0773



0933



0933

# Gabriel Step melange | category B



## Application

Contract

## Composition

100% Trevira cs

## Environmental

Oeko-Tex, EU Ecolabel

100% free of heavy metals

## Width

140cm

## Weight

470 g/lm

15.16 oz/lin.yd

## Flame resistance

IMO MSC 307(88) Annex 1 part 8

MED Certificate IMO

DIN 4102 B1

NFP 92-503/504/505 M1

BS EN 1021 1&2 Cigarette and Match

BS 5852 Part 1 0,1 Cigarette & match

BS 5852 Crib 5

ÖNORM B 3825-B1-3800-Q1 UK

FAR/JAR 25.853 (a) (i) (ii)

BS 7176 Medium hazard

AM 18 - NF D 60-013-(only for fabric)

CA TB 117-2013

Class Uno UNI 9175 Class 1 I EMME

DIN EN 13501-1 B-s1,d0

## Abrasion resistance

100,000 Martindale cycles

## Fastness to Rubbing

4-5/4-5 scale 1-5, max. 5 -

EN ISO 105x12 (wet/dry)

## Cleaning

Wash or dry cleaning P(W).

## Colours

Colours can differ from image,  
for a true colour perspective  
and up to date colour card,  
please visit the brand website.



# Kvadrat Remix 2 | category C



**Application**  
Upholstery

**Composition**  
90% New wool and 10% Nylon

**Environmental**  
EU Ecolabel

**Width**  
138cm

**Weight**  
415 g/lin.m

**Flame resistance**  
EN 1021-1/2  
BS 5852 part 1  
Önorm B1/Q1  
NF D 60 013  
UNI 9175 1IM  
AS/NZS 1530.3  
US Cal. Bull. 117-2013  
NFPA 260  
IMO FTP Code 2010: Part 8

**Abrasion resistance**  
100,000 Martindale cycles

**Cleaning**  
Vacuuming and dry cleaning.

**Colours**  
Colours can differ from image,  
for a true colour perspective  
and up to date colour card,  
please visit the brand website.



# Kvadrat Hero | category C

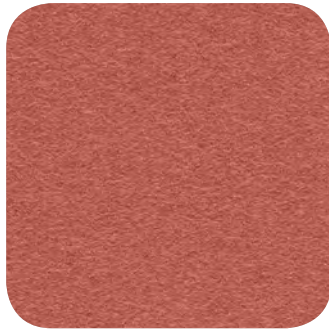

**Application**

Upholstery

**Composition**

96% new wool and 4% nylon

**Environmental**

EU Ecolabel

**Width**

App. 140cm

**Weight**

App. 580/lin.m

**Flame resistance**

AS/NZS 3837 class 2

BS 5852 Crib 5 with treatment

BS 5852 part 1

DIN 4102 B2

EN 1021-1/2

IMO FTP Code 2010: Part 8

NF D 60 013

NFPA 260

SN 198 898 5.3 with treatment

UNI 9175 1IM

US Cal. Bull. 117-2013

**Abrasion resistance**

45,000 Martindale cycles

**Cleaning**

Vacuuming and dry cleaning.

Avoid using steam.

**Colours**

Colours can differ from image,  
for a true colour perspective  
and up to date colour card,  
please visit the brand website.

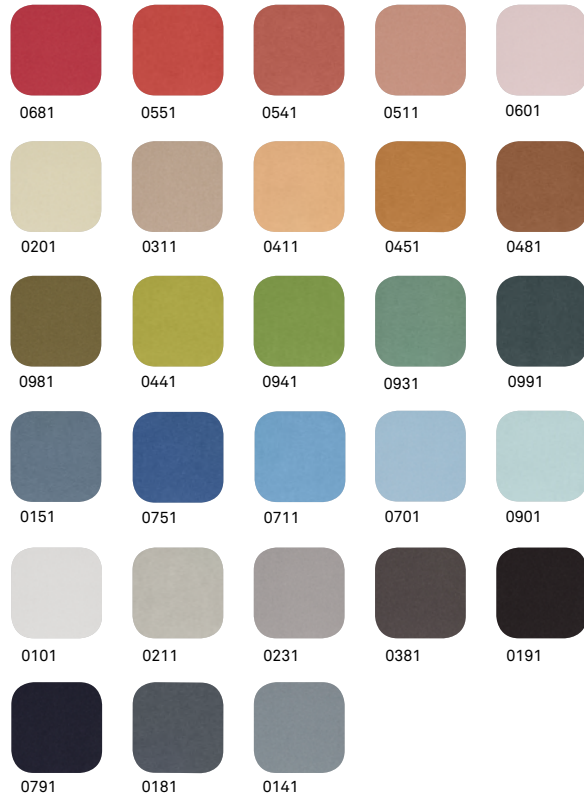

# Camira Synergy | category C



## Application

Task seating, soft seating  
and curtain

## Composition

95% Virgin Wool and 5% Polyamide

## Environmental

EU Ecolabel

## Width

140 cm minimum

## Weight

400 g/m<sup>2</sup> ±5% (560 g/lin.m ±5%)

## Flame resistance

EN 1021 - 1 (cigarette)

EN 1021 - 2 (match)

BS 7176 Low Hazard

NF D 60-013

ÖNORM B 3825 & A 3800-1

(58 kg/m<sup>3</sup> CMHR Foam)

UNI 9175 Classe 1 IM

EN 13501 Adhered Class D, s1, d0

EN 13501 Un-adhered Class E, s2, d0

## Abrasion resistance

100,000 Martindale cycles

## Fastness to Rubbing

Wet: 4, Dry: 4 (ISO 105 - X12)

## Cleaning

Vacuum regularly. Professionally dry clean  
or wipe clean with a damp cloth.

## Colours

Colours can differ from image,  
for a true colour perspective  
and up to date colour card,  
please visit the brand website.



LDS74



LDS72



LDS36



LDS07



LDS66



LDS67



LDS70



LDS87



LDS79



LDS86



LDS85



LDS76



LDS73



LDS84



LDS71



LDS80



LDS81



LDS82



LDS75



LDS83



LDS18



LDS22



LDS77



LDS78



LDS39



LDS37



LDS33



LDS32



LDS19



LDS20



LDS08



LDS23



LDS45



LDS44



LDS28



LDS43



LDS48



LDS46



LDS47



LDS53



LDS52



LDS54



LDS49



LDS51



LDS59



LDS50



LDS60



LDS42



LDS41



LDS40



LDS27



LDS61



LDS62



LDS68



LDS63



LDS64



LDS65



LDS57



LDS55



LDS56



LDS56



LDS24



LDS29



LDS25



LDS69



LDS88



LDS26



LDS17



LDS34



LDS38



LDS35



LDS31



LDS16



LDS21



LDS05

# Camira Blazer | category C



## Application

Task seating, soft seating  
and curtain

## Composition

100% Virgin Wool  
Non metallic dyestuffs

## Environmental

Rapidly renewable and compostable

## Width

140 cm minimum

## Weight

460 g/m<sup>2</sup> ±5% (645 g/lin.m ±5%)

## Flame resistance

EN 1021 - 1 (cigarette)

EN 1021 - 2 (match)

BS 7176 Low Hazard

NF D 60-013

ÖNORM B 3825 & A 3800-1

(58kg/m<sup>3</sup> CMHR Foam)

UNI 9175 Classe 1 IM

BS 476 Part 7 Class 1

EN 13501-1 Adhered Class D, s1, d0

## Abrasion resistance

50,000 Martindale cycles

## Fastness to Rubbing

Wet: 4, Dry: 4 (ISO 105 - X12)

## Cleaning

Vacuum regularly. Professionally dry clean  
or wipe clean with a damp cloth.

## Colours

Colours can differ from image,  
for a true colour perspective  
and up to date colour card,  
please visit the brand website.

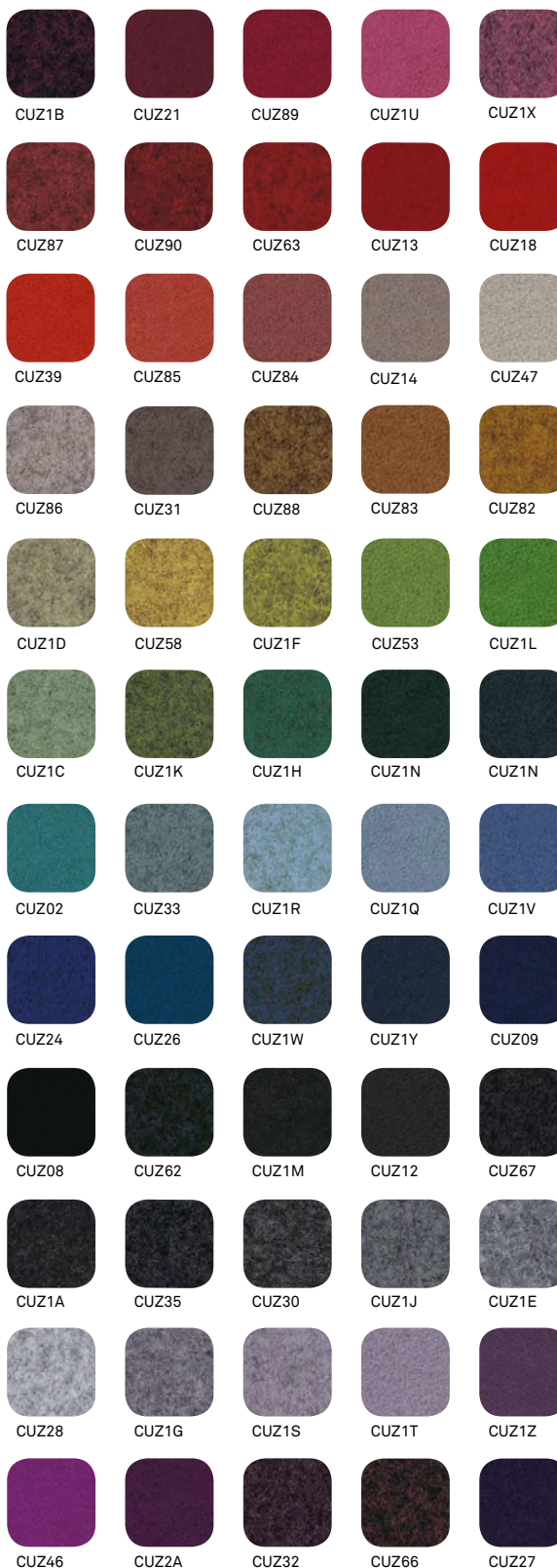

# Serge Ferrari Stamskin Top | category C



## Application

Task seating

## Composition

Underlayer Polyamid- jersey

## Environmental

Recyclable

## Width

140cm

## Weight

780 g/m<sup>2</sup>

## Flame resistance

EN 1021 - 1 (cigarette)

EN 1021 - 2 (match)

SN 198898 – VKF/AEAI

BS 5852 crib 5

DIN 4102 B1

UNI 9175 Classe 1 IM

## Abrasion resistance

120,000 Martindale cycles

## Cleaning

Visit the Sergio Ferrari website for a detailed explanation.

## Colours

Colours can differ from image, for a true colour perspective and up to date colour card, please visit the brand website.



# Vyva fabrics Sylverguard | category C

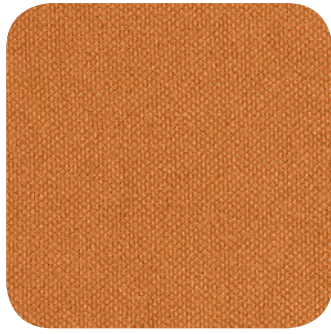

## Application

Upholstery

## Composition

Vinyl/Urethane Topcoat met Hi-Loft<sup>2</sup> backing

## Width

137cm

## Weight

685 g/m<sup>2</sup>

## Flame resistance

EN 1021-1/2

IMO FTP Code 2010 MSC.307: Part 8

BS5852 part 1

UNI 23.727-90 1R/M2

NF P 92-503/M2

DIN 4102 B2

UNI 9175/UNI 9175/Fa1 1IM

ÖNORM B 3825,

Gruppe 1-Schwerbrennbares Verhalten

ÖNORM A 3800 Teil 1,

Qualmbildungsklasse Q1

FMVSS 302/FAR 25.853

## Abrasion resistance

30,000 Martindale cycles

## Cleaning

Damp cloth with soap water,  
do not use abrasive cleaner.

## Colours

Colours can differ from image,  
for a true colour perspective  
and up to date colour card,  
please visit the brand website.





# Kvadrat Divina 3 | category D



**Application**

Upholstery

**Composition**

100% new wool

**Environmental**

EU Ecolabel

**Width**

150cm

**Weight**

Approx. 840 g/lin.m

**Flame resistance**

AS/NZS 1530.3

BS 5852 Crib 5

BS 5852 part 1

DIN 4102 B2

EN 1021-1/2

IMO FTP Code 2010:Part 8 NF D 60 013

**Abrasion resistance**

45,000 Martindale cycles

**Cleaning**

Vacuuming and dry cleaning.

Avoid using steam.

**Colours**

Colours can differ from image, for a true colour perspective and up to date colour card, please visit the brand website.



# Kvadrat Divina melange 2 | category D



**Application**

Upholstery

**Composition**

100% new wool

**Environmental**

EU Ecolabel

**Width**

150cm

**Weight**

Approx. 820 g/lin.m

**Flame resistance**

AS/NZS 1530.3

BS 5852 Crib 5

BS 5852 part 1

DIN 4102 B2

EN 1021-1/2

IMO FTP Code 2010:Part 8

NF D 60 013

NFPA 260

Önorm B1/Q1

SN 198 898 5.3 with treatment

UNI 9175 1IM

US Cal. Tech. Bull. 117 AS.NZS 1530.3

**Abrasion resistance**

45,000 Martindale cycles

**Cleaning**

Vacuuming and dry cleaning.

**Colours**

Colours can differ from image,  
for a true colour perspective  
and up to date colour card,  
please visit the brand website.



# Kvadrat Hallingdal 65 | category D

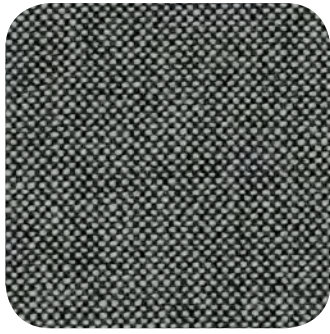

**Application**

Upholstery

**Composition**

70% new wool and 30% viscose

**Environmental**

EU Ecolabel

**Width**

130cm

**Weight**

Approx. 795 g/lin.m

**Flame resistance**

EN 1021-1/2

BS 5852 Crib 5

BS5852 part 1

DIN 4102 B2

Önorm B1/Q1

NF D 60 013

NFPA 260

SN 198 898 5.3 with treatment

UNI 9175 1IM

US Cal. Bull. 117 – 2013

IMO FTP Code 2010: Part 8

**Abrasion resistance**

100,000 Martindale cycles

**Cleaning**

Vacuuming and dry cleaning.

**Colours**

Colours can differ from image, for a true colour perspective and up to date colour card, please visit the brand website.



# Kvadrat Steelcut 2 | category D



**Application**

Upholstery

**Composition**

90% wool and 10% nylon

**Environmental**

EU Ecolabel

**Width**

150cm

**Weight**

Approx. 825 g/lin.m

**Flame resistance**

EN 1021-1/2

BS 5852 part 1

DIN 4102 B2

Önorm B1/Q1

NF D 60 013

UNI 9175 1IM

US Cal. Tech. Bull. 117 NFPA 260

AS/NZS 3837

IMO FTP Code 2010: Part 8

**Abrasion resistance**

80,000 Martindale cycles

**Cleaning**

Vacuuming and dry cleaning.

**Colours**

Colours can differ from image, for a true colour perspective and up to date colour card, please visit the brand website.



# Kvadrat Steelcut trio 3 | category D

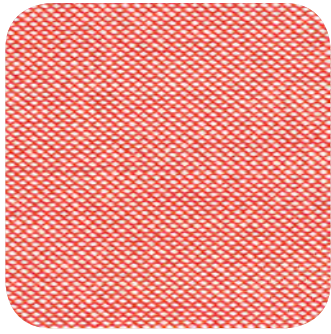

**Application**

Upholstery

**Composition**

90% wool and 10% nylon

**Environmental**

EU Ecolabel

**Width**

140cm

**Weight**

Approx. 770 g/lin.m

**Flame resistance**

EN 1021-1/2

BS 5852 part 1

DIN 4102 B2

Önorm B1/Q1

NF D 60 013

UNI 9175 11M

US Cal. Bull. 117, – 2013

NFPA 260

AS/NZS 3837

IMO FTP Code 2010: Part 8

**Abrasion resistance**

100,000 Martindale cycles

**Cleaning**

Vacuuming and dry cleaning.

**Colours**

Colours can differ from image, for a true colour perspective and up to date colour card, please visit the brand website.



# Camira Cara | category P0



## Application

Panel

## Composition

100% Polypropylene

## Environmental

EU Ecolabel

## Width

170 cm minimum

## Weight

220 g/m<sup>2</sup> ±5% (375 g/lin.m ±5%)

## Flame resistance

EN 1021-1 (cigarette)

BS 476 Part 7 Class 1

EN 13501-1 Adhered Class B, s2 ,d0

## Fastness to Rubbing

Wet: 4, Dry: 4 (ISO 105 - X12)

## Cleaning

Vacuum regularly. Wipe clean with a damp cloth or shampoo using proprietary upholstery shampoo.

## Colours

Colours can differ from image, for a true colour perspective and up to date colour card, please visit the brand website.

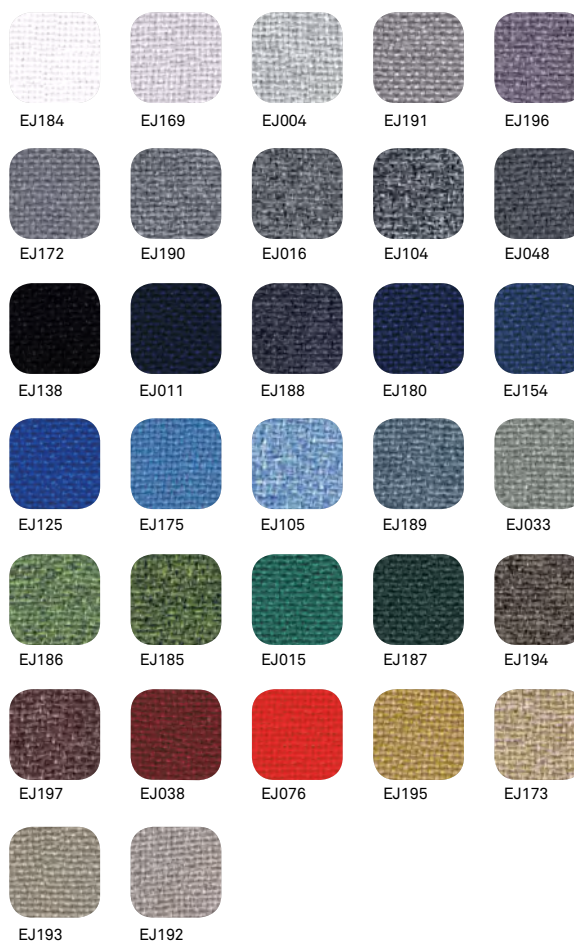

# Gabriel Soul | category P1

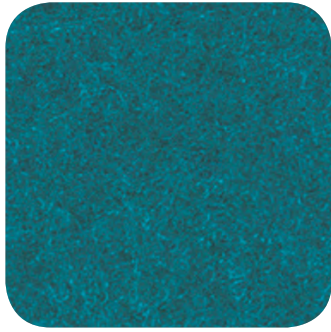

## Application

Panel

## Composition

100% wool

## Environmental

Oeko-Tex

100% free of heavy metals

## Width

170cm

## Weight

330 g/lm

10.64 oz/lin.yd

## Flame resistance

BS 476 Part 7 Class 1

ÖNORM B 3825-B1-3800-Q1 UK

## Fastness to Rubbing

4/4-5 scale 1-5, max. 5 -

EN ISO 105x12 (wet/dry)

## Cleaning

Regular vacuum cleaning.

## Colours

Colours can differ from image,  
for a true colour perspective  
and up to date colour card,  
please visit the brand website.



60097



60100



60098



60099



60999



66104



66103



67039



68068



68086



68088



61112



68087



63051



63050



64060



64071



65057



65058

# Camira Racer | category P1

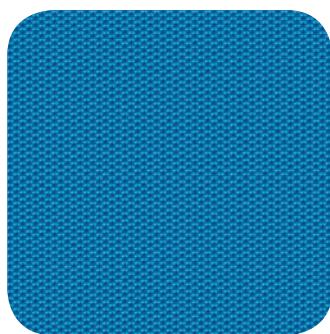

## Application

Panel

## Composition

100% Polyester,  
Non metallic dyestuffs

## Width

170 cm minimum

## Weight

300 g/m<sup>2</sup> ±5% (510 g/lin.m ±5%)

## Flame resistance

BS 476 Part 7 Class 1  
EN 13501-1 Adhered Class B, s2, d0  
EN 13501-1 Un-adhered Class B, s1, d0

## Fastness to Rubbing

Wet: 4, Dry: 4 (ISO 105 - X12)

## Cleaning

Vacuum regularly. Wipe clean with  
a damp cloth or shampoo using  
proprietary upholstery shampoo.

## Colours

Colours can differ from image,  
for a true colour perspective  
and up to date colour card,  
please visit the brand website.



NU044



NU045



NU039



NU032



NU037



NU033



NU021



NU004



NU029



NU028



NU005



NU046



NU003



NU007



NU016



NU048



NU026



NU022



NU027



NU023



NU047



# Gabriel Twist Melange | category P1



## Application

Panel

## Composition

100% Trevira cs

## Environmental

Oeko-Tex, EU Ecolabel  
100% free of heavy metals

## Width

170cm

## Weight

370 g/lm  
11.93 oz/lin.yd

## Flame resistance

ASTM E 84  
DIN 4102 B1  
NFP 92-503/504/505 M1  
BS 476 Part 7, class 1  
Class Uno UNI 9175 Class 1 | EMME  
Class Uno UNI 9177 - Class 1 | EMME  
Class Uno UNI 9174 - UNI 8457  
DIN EN 13501-1 B-s1,d0

## Fastness to Rubbing

4-5/4-5 scale 1-5, max. 5 -  
EN ISO 105x12 (wet/dry)

## Cleaning

Wiping down with water.

## Colours

Colours can differ from image,  
for a true colour perspective  
and up to date colour card,  
please visit the brand website.



60004



60076



60011



60021



61102



63075



64013



63012



61103



61104



62066



68119



68120



68118



67004



66018



65018

# Camira Blazer Lite | category P2



## Application

Panel

## Composition

100% Virgin Wool  
Non metallic dyestuffs

## Environmental

Rapidly renewable and compostable

## Width

170 cm minimum

## Weight

355 g/m<sup>2</sup> ±5% (605 g/lin.m ±5%)

## Flame resistance

BS 476 Part 7 Class 1  
BS 476 Part 6 Class 0  
EN 13501-1 Adhered Class C, s1, d0

## Fastness to Rubbing

Wet: 4, Dry: 4 (ISO 105 - X12)

## Cleaning

Vacuum regularly. Professionally dry clean  
or wipe clean with a damp cloth.

## Colours

Colours can differ from image,  
for a true colour perspective  
and up to date colour card,  
please visit the brand website.



# Kvadrat Floyd screen | category P2



0106



0246



0226



0416



0926



0946



0726



0126



0146



0216



0266



0626

## Application

Panel

## Composition

45% new wool, 50% polyester and 5% nylon

## Width

App. 170 cm (app. 67 inches)

## Weight

App. 370 g/lin.m

## Flame resistance

BS 476 part 7 + 6 when glued

## Cleaning

Vacuuming and dry cleaning.

## Colours

Colours can differ from image,  
for a true colour perspective  
and up to date colour card,  
please visit the brand website.

# Camira Synergy 170W | category P2



## Application

Panel

## Composition

95% Virgin Wool and 5% Polyamide

## Environmental

EU Ecolabel

## Width

140 cm minimum

## Weight

400 g/m<sup>2</sup> ±5% (560 g/lin.m ±5%)

## Flame resistance

EN 1021 - 1 (cigarette)

EN 1021 - 2 (match)

BS 7176 Low Hazard

NF D 60-013

ÖNORM B 3825 & A 3800-1

(58 kg/m<sup>3</sup> CMHR Foam)

UNI 9175 Classe 1 IM

EN 13501 Adhered Class D, s1, d0

EN 13501 Un-adhered Class E, s2, d0

## Abrasion resistance

100,000 Martindale cycles

## Fastness to Rubbing

Wet: 4, Dry: 4 (ISO 105 - X12)

## Cleaning

Vacuum regularly. Professionally dry clean or wipe clean with a damp cloth.

## Colours

Colours can differ from image, for a true colour perspective and up to date colour card, please visit the brand website.

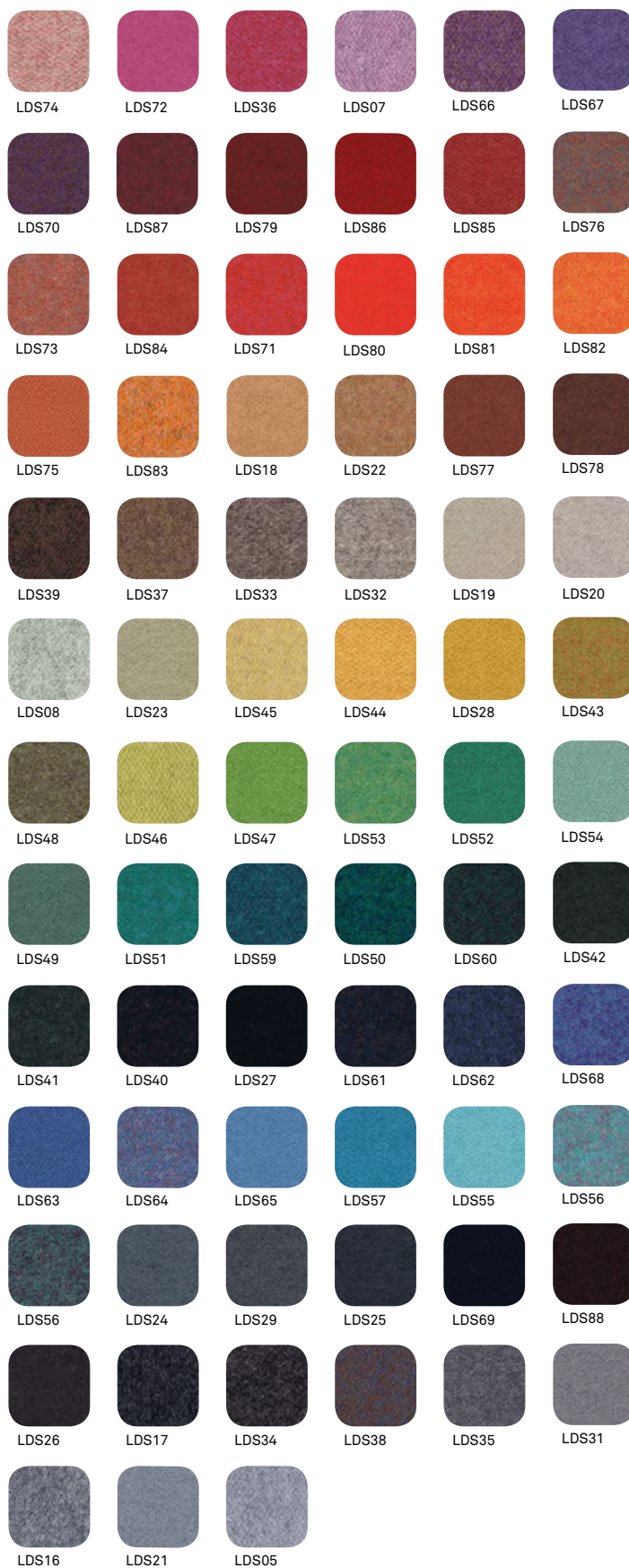

# Projects



PORTHOUSE, ANTWERP BELGIUM

Architect: Zaha Hadid Architects Photography: Sarah Blee

Products: Pillow acoustic space dividers | Round20 whiteboards  
Focus brochure stands

CASCANDO





RABOBANK, NIJMEGEN THE NETHERLANDS  
Interior architect: Quub Interior Concepts Photography: Rob Kater  
Products: Leaf whiteboards | Pillow acoustic wall panels  
Bamboo coat stands



MATRIX SPECIALTY LUBRICANTS, DUIVEN THE NETHERLANDS  
Interior architect: Cascando studio Photography: Rob Kater  
Products: Round20 series | Pillow acoustic panels | Blog tables







ÖSTERREICHISCHE POST AG, VIENNA AUSTRIA

Architects: Schenker Salvi Weber Architekten / Feld 72 Architekten

Photography: Lukas Schaller Products: Team seating elements | Paddy poufs  
Trunk acoustic space dividers | Trunk whiteboards | U2 tables



UNIVERSITY OF STUTTGART LEARNING CENTER, STUTTGART GERMANY  
Architects: Heinle, Wischer und Partner - Freie Architekten Photography: Brigida Gonzalez  
Products: Team seating | Team solid panel system | Flow tables



QWIC ELECTRIC BIKES, AMSTERDAM THE NETHERLANDS  
Interior architect: Fleur van der Storm Photography: Rob Kater  
Products: Pillow Space dividers | Paddy poufs



MOBILE BOUTIQUE NEEDS & WANTS STUDIOS, TORONTO CANADA  
Design: Marco Lee Photography: James C. Lee  
Product: Lean On coat stand



STUDIO ROBERT BRONWASSER, AMSTERDAM THE NETHERLANDS  
Interior design: Robert Bronwasser Photography: Jansje Klazinga  
Products: Blog tables | Pillow Grid panels



# Incorporate Cascando into your digital plans: CAD data, pCon.planner, OFML data

Cascando CAD data are freely available via our website or via pCon.catalogue (go to <http://pcon-catalog.com/cascando>). You may also use pCon.planner which provides complete OFML-data, 2D and 3D drawings of our products. pCon.planner is a multifunctional planner that you can use to create 3D interior designs and presentations in just a few steps. The graphical representations of our products, in both 2D and 3D, have been enhanced using OFML (Office Furniture Modeling Language). OFML data contains additional information such as article numbers, recommended retail prices and product descriptions. You can configure the products easily by selecting options in a step-by-step process.

Cascando makes its data available via the software package pCon.update. With pCon.update you download the required drawings and OFML-enhanced data online when you need them. As the database is managed online, the data is always available quickly, efficiently and inexpensively. Most importantly, however, you can be sure that you are

always working with up-to-date data and drawings. Are you already a pCon.planner user? If so, download the Cascando data via your existing installation of the auxiliary program DataClient. Are you not yet a pCon.planner user? Download the free marketing version of pCon.update. Register via <https://update.easterngraphics.com/registration/CADO79>

Unsere CAD Daten sind frei zugänglich auf unsere Homepage und im pCon.catalogue (<http://pcon-catalog.com/cascando>). Oder Sie verwenden pCon.planner für die komplette OFML Daten, 2D und 3D Daten unserer Produkten. PCon.planner ist ein multifunktionaler Planer, mit dem man in wenigen Schritten Einrichtungsentwürfe und Präsentationen in 3D erstellen kann. Die grafischen Darstellungen unserer Produkte – in sowohl 2D als 3D – wurden mit OFML (Office Furniture Modeling Language) angereichert. OFML-Daten enthalten Zusatzinformationen wie Artikelnummern, Preisempfehlungen und Produktbeschreibungen. Die Produkte können anhand schrittweiser

Auswahlmöglichkeiten einfach konfiguriert werden.

Cascando stellt Ihnen seine Daten über das Softwarepaket pCon.update zur Verfügung. Mit pCon.update werden die erforderlichen Zeichnungen und mit OFML angereicherten Daten aus dem Internet heruntergeladen, sobald Sie sie brauchen. Da die Datenbank online verwaltet wird, werden die Daten immer schnell, effizient und kostengünstig zur Verfügung gestellt. Das Wichtigste ist jedoch, dass Sie immer mit völlig aktuellen Daten und Zeichnungen arbeiten. Sie nutzen pCon.planner bereits? Dann können Sie die Cascando-Daten einfach über ihre bestehende Installation des Hilfsprogramms DataClient laden. Sie nutzen pCon.planner noch nicht? Dann holen Sie sich die kostenfreie Marketingversion pCon.update: registrieren Sie sich auf <https://update.easterngraphics.com/registration/CADO79>

➔ More info on: [www.cascando.nl](http://www.cascando.nl)





# Product index

## Seating



Team LSM | 24



Team LSM | 24



Team BSM | 28



Team BSM | 28



Team BSM - SPS | 34



Team SPS | 50



Team TPS | 52



Team TPS | 52



Pully | 40



Paddy | 42



Team Pouf | 44



Pillow Desk | 76



Trunk Desk | 96

## Privacy and acoustic furniture



Pillow Wall | 56



Pillow Grid | 64



Pillow Round | 74

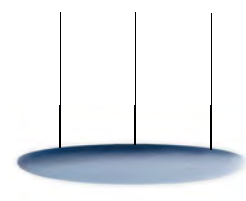

Pillow Free | 78



Trunk | 90



Pillow Space | 80



Round20 Alu | 88



Round20 Wood | 88

Coat stands



Coat racks

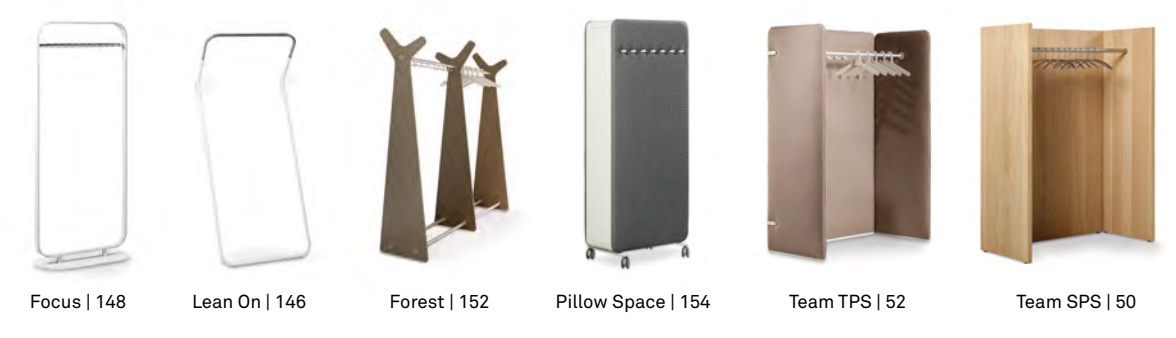

# Product index

## Coat hooks



Hemisphere | 169



Tango | 170



Velvet | 174



Flake | 171



Bend | 168



Flow | 158



Round20 | 160



Hagon | 162



Clickon | 167



Stick | 166



Round 20 | 160



Kangaroo | 175



Branch | 176



Bamboo Wall | 172



Hagon 7 | 164



Hagon 12 | 164



Hagon Double | 162



Flow | 158

## Coat hangers



Chrome | 183

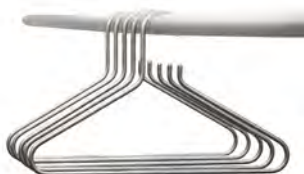

Lean On | 182



Pole | 180

Tables



Blog Talk | 188



Blog Meet | 190



Blog Work | 186



Team Table | 192



Team Table | 192



Team Light Table | 201



Flow | 196



Cobalt | 199



Stainless | 200



XL | 206



Velvet | 197



Frost | 209



Careo | 195



Exxentrique | 207



Laptop | 198



Platform | 208



Basket | 194



Paddy | 202



U2 | 204



Rombo | 203

# Product index

## Display and storage



Flexible Single | 226



Flexible Double | 226



Flexible Large | 224



Focus | 220



Leaf | 219



Round20 Wood | 214



Round20 Alu | 218



Round20 Delta | 216



Box01 | 230



Box01 | 230



Frame | 222



Frame | 222



Frame | 222



Round20 Wall | 212



Round20 Wall | 212



PS door | 80



PS shelves | 80



PS magazine holders | 80



PS lockers | 80



PS drawer | 80



PS magazine | 80



PS screen support | 80



Trunk screen support | 236



Pillow Wall | 56

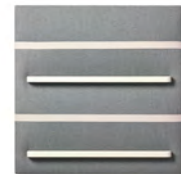

Pillow Grid | 64

Whiteboards



Pillow Grid | 240



Round20 Wall | 244



Round20 Wood | 246



Round20 Alu | 246



Round20 Delta | 246



Round20 Wood | 246



Trunk | 236



Pillow Space | 242



Pillow Space | 242



Leaf | 238

Planters



Pillow Space | 250



Rombo | 251

Umbrella stands



Flow I | 254



Flow II | 256



Square | 256



Round20 | 258



Standin | 259



Velvet | 260



Flower | 261

Paperbins



Flow | 264



Flow | 264



Square | 266



Square | 266







# Sales & Contact

## Head office

Cascando Products b.v. T +31(0)26 35 19 603  
Impact 2 F +31(0)26 35 19 808  
NL-6921 RZ Duiven E design@cascando.nl  
The Netherlands I www.cascando.nl

## STAY CONNECTED:



## Regional sales offices

### AUSTRIA

Design4Architects  
Franz Steiner  
St. Severinstrasse 32/5  
A-3313 Wallsee  
T 0043-6649116177  
E franz.steiner@design4architects.com

### BELGIUM

Concep'trade  
mevr. Herreman / dhr Vanherck  
Klein Begijnhof Bogaard 5  
B-2800 Mechelen  
T 0032-15330725  
F 0032-15330719  
E info@conceptrade.be

### FRANCE

Wagemans Mobilier  
Daniel Wagemans  
496 Route des Pinoux  
F-01570 Manziat  
T 0033-385301029  
E info@wagemans.fr

### DENMARK

Arnesco Scandinavia  
Hellerupvej 10 - Baghuset 1 sal  
DK 2900 Hellerup CPH  
T 0045-43711938  
M0045-40571938  
E info@arnesco.dk

### GERMANY PLZ 0 & 99

Handelsagentur Richter  
Eberhard Richter  
Louis-Braille-Strasse 21  
D-99510 Apolda  
T 0049-3644517527  
F 0049-3644617528  
E agentur.richter@t-online.de

### GERMANY PLZ 2 & 3

Idea-Objekt Hannover  
Uwe Wöhlk  
Tiestestrasse 36  
D-30173 Hannover  
T-0049-5112283334  
F 0049-5112283348  
E uwe@idea-objekt.com

### GERMANY PLZ 4 & 5

objectiv Raumakustik + Möbel  
Pieter Niessen  
Waltherstrasse 49-51  
D-51069 Koeln  
T 0049-221 / 16 88 98-0  
F 0049-221 / 16 88 98-20  
E niessen@objectiv.de

### GERMANY PLZ 6

FREIRAUM  
Michael Günter Frei  
Bahnhofstrasse 31  
D-61130 Nidderau - Heldenbergen  
T 0049-61879097316  
F 0049-61879097318  
E michaelfrei@freiraum-mf.de

### GERMANY PLZ 7, 8 & 9

Idea-Objekt München  
Volker Breuckmann  
Erminoldstrasse 88  
D-81735 München  
T 0049-8968072862  
F 0049-8968072863  
E info@idea-objekt.com

### LUXEMBOURG

Concep'trade  
mevr. Herreman / dhr Vanherck  
Klein Begijnhof Bogaard 5  
B-2800 Mechelen  
T 0032-15330725  
F 0032-15330719  
E info@conceptrade.be

### NORWAY

Arnesco Scandinavia  
Hellerupvej 10 - Baghuset 1 sal  
DK 2900 Hellerup CPH  
T 0045-43711938  
M0045-40571938  
E info@arnesco.dk

### SPAIN

Absolutdesign - Rubio showroom  
Paula Espinar  
C/Volta 38-42  
08224 Terrassa (Barcelona)  
T 0034-630789214  
E info@absolutdesign.es

### SWEDEN

Arnesco Scandinavia  
Hellerupvej 10 - Baghuset 1 sal  
DK 2900 Hellerup CPH  
T 0045-43711938  
M0045-40571938  
E info@arnesco.dk

### SWITZERLAND

Agentur Geiger GmbH  
Marc Geiger  
Tannenbodenstrasse 6  
CH-6045 Meggen  
T 0041-448881100  
F 0041-448881101  
E info@agentur-geiger.ch

### UK

Crest London  
Unit 211  
Westminster Industrial Estate  
13 Westfield Street  
London  
SE18 5PH  
T 044-2088544229  
E hello@crest.london



# Colophon

## OFFICE & SHOWROOM

Impact 2  
NL-6921 RZ Duiven  
The Netherlands

## STUDIO PHOTOGRAPHY

Paul Lagro

## PORTRAIT PHOTOGRAPHY

Wouter Jansen

## CONCEPT & ART DIRECTION

Smel \*design agency

## GRAPHIC DESIGN

Margriet van Sonsbeek

## IDENTITY & STYLING

Martine de Schipper

## TEXT

<JNSN> Arold Jansen

## PRINT

Drukkerij Tesink

### © 2018 Cascando

Cascando is a registered trademark. All Cascando designs are registered worldwide at the World Intellectual Property Organisation (WIPO) in Geneva. Any infringement of trademark law or design and model law will lead to prosecution.

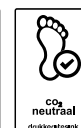

# Cascando Products b.v.

Impact 2  
NL-6921 RZ Duiven  
The Netherlands

T +31(0)26 35 19 603  
F +31(0)26 35 19 808  
E [design@cascando.nl](mailto:design@cascando.nl)  
I [www.cascando.nl](http://www.cascando.nl)

STAY CONNECTED:



Cascando